



Enjoy Mobility



K-MONO™
KNEE UNIQUE SOLUTIONS

OPERATING TECHNIQUE

Patent pending

| EN |

K-MONOTM KNEE UNIQUE SOLUTIONS



The patented K-MONO system is a synthesis of the innovations in unicompartamental femorotibial fixed insert knee prosthetics that have proven their clinical effectiveness. A unique and complete system thanks to the range of possibilities designed to satisfy the individual surgeon's approach to the individual patient.

The K-MONO system is one of a kind in fact, as it allows a dual approach in the femoral part:

- the RES (resurfacing) version is the most conservative, as it only involves removal of the cartilage at distal level and its replacement with a 4mm thick femoral shield;
- the 3CUT version (3 resections: distal, posterior and oblique) is naturally more guided and reproducible, but maintains the characteristics of reduced invasiveness thanks to a constant thickness, from distal to posterior, of less than 7mm.

The anatomical tibial component accepts both femoral components, RES and 3CUT. It is a double AP ellipse with very low congruence, so that the measurements of the femoral and tibial components are independent of each other. It is available in two versions: MetalBack (cobalt-chrome or titanium alloy tibia and polyethylene insert) and AllPoly (completely in polyethylene).

Polyethylene is also available in the latest generation version, with X-link treatment and added vitamin E, specially developed for knee prostheses. The thicknesses indicated (8, 9, 10, 12mm) are those of the tibial component in its entirety.

The K-MONO system supports cemented, uncemented and anallergic applications. All articular surfaces, femoral and tibial, are mirror polished.

The instruments are modular, compact and easy to use. The technique starts with tibial resection: the guide is minimally invasive and doesn't weaken the tibial bone below the cut. Fundamental control of the joint line and correct balancing are ensured by modular spacer blocks. The preparations for the two femur models are different. It is possible to proceed with the trial reduction even after definitive MetalBack femur and tibia implantation.

Special ancillary tools (retractors, rasp, etc.) support the surgical procedure.

INDEX

[PREOPERATIVE PLAN]	4
[INSTRUMENT PREPARATION]	5
[SURGICAL PREPARATION]	6
[TIBIA: RESECTION].....	7
[FEMUR 3CUT]	11
[FEMUR RES]	15
[FLEXION GAP]	18
[TIBIA ALLPOLY].....	19
[TIBIA METALBACK].....	20
[TRIAL REDUCTION].....	21
[DEFINITIVE IMPLANTS].....	22
[OPTIONS].....	26
[SYNOPTIC TABLES]	30
[IMPLANTS]	32
[INSTRUMENTS].....	36
[TEMPLATES].....	42

Symbols legend



IMPORTANT! These indications draw attention to special and/or critical elements.



INSTRUMENT PRE-SETTING RECOMMENDATIONS.

These indications reflect common surgical practice. They are intended not to be binding but to facilitate the pre-setting of certain instruments, especially for the instrumentation nurse.

PREOPERATIVE PLAN

On the patient's most recent X-rays, produce an accurate pre-operative plan in the AP and ML planes using the K-MONO X-ray transparencies: K-MONO X-Ray Template Fem 3CUT/RES, Tib Metal Back/ AllPoly (KMONO-XR-000÷003).

Evaluate (15% magnification): the measurements of the femoral and tibial components and the articular line.

Evaluation is always indicative and must be verified and possibly modified intra-operatively.

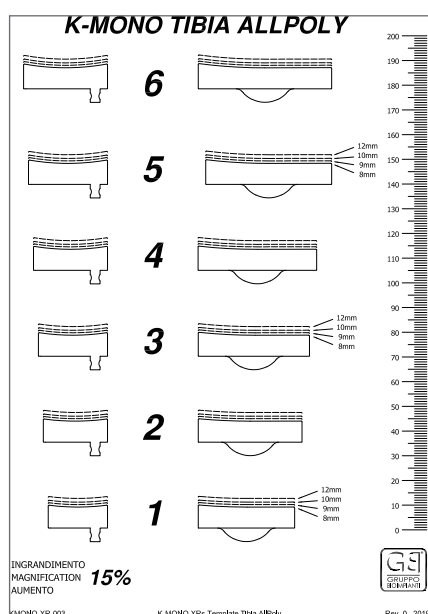
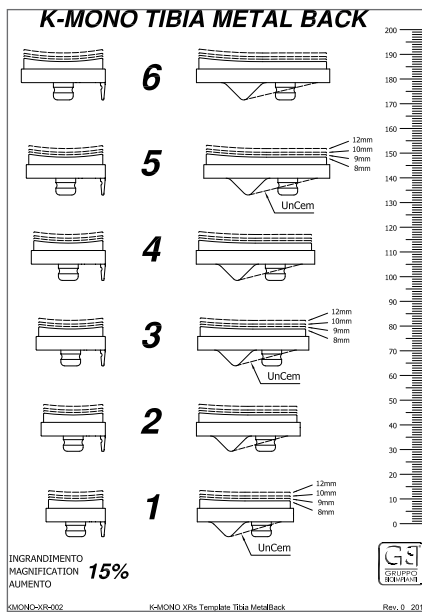
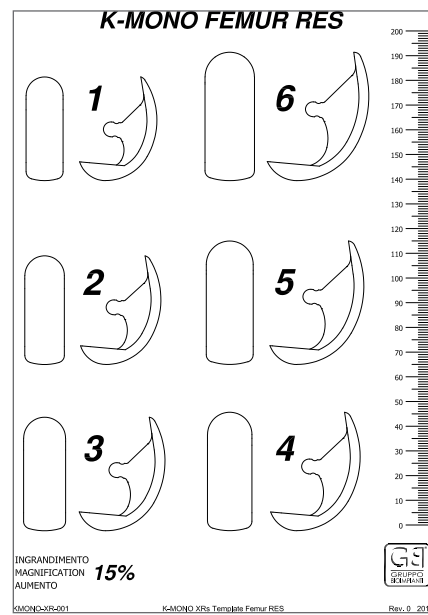
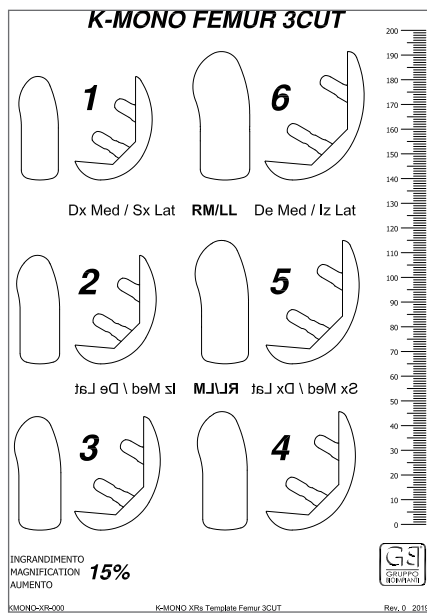

INSTRUMENTS PREPARATION

In order to facilitate the nurse's infra-op tasks, the instrumentation consists of just two basic trays, to which the specific femoral one may be added, as outlined below:

- Two basic trays:
TIBIAL INSTRUMENTS (300114400);
COMMON INSTRUMENTS (300114401).
- Choice of femur:
3CUT femur with resections: FEMUR 3CUT INSTRUMENTS (300114403);
RES femur with resurfacing: FEMUR RES INSTRUMENTS (300114402).
- One optional tray:
OPTION NATURAL INSTRUMENT (300114404).
This contains tools for the following options:
 - implantation of screws for the cementless tibial component
 - Cartier line medial tibial resection (3 and 6 degrees)
 - 3CUT distal femoral resection: further options (1 and 3mm) for compensating bone defects
- Oscillating saw blades
The resection slots accept oscillating saw blades up to a thickness of 1.27mm.
Indicatively, we recommend blades that are fairly narrow (about 12/13mm), not excessively long (about 90/100mm) and 1,27mm thick.
- Reciprocating saw blades
A reciprocating saw is required for vertical tibial resection. We recommend blades with the cutting edge on one side only.
- Pins
Different types of pin are available in the instrumentation. Powered insertion with the Jacobs Adapter (300110377) is preferable to using the hammer. Always manually insert the pin into the hole in the guide or resection block until the tip comes into contact with the bone, and then proceed with insertion into the bone, taking care to stay in line.
To remove pins, use the power tool or Pin Extractor (300110276).
Only the Headed Pin For Baseplate (300110197) is inserted using the hammer and removed with the Universal Handle/Pin Extractor (300110281).
We recommend keeping at least 2 pins available per type.
For certain steps, the surgical technique indicates which pins are to be preferred.

The available pins are:

Smooth pin length 80mm (300110144) Short smooth pin with head (300110197)



Smooth pin length 40 with stop (300110198)



Short threaded pin (300114135)



- Retractors

The instrumentation provides two types of retractor:
Patella Retractor (300114130): to be inserted by levering against the femoral condyle in the part towards the neck. The knurled tip facilitates its support on the bone.



Collateral S Retractor (300114131): to be inserted to protect the collateral ligament. The blunt tip facilitates its insertion.



- Rasp for vertical tibial resection

Vertical tibial resection is a critical factor for the correct insertion of the tibial component. To this end, the instrumentation includes the Tibial Rasp (300114004), specifically designed to clean up this resection. It has two different types of grain (fine and gross). The bottom side is also used to clean up the horizontal tibial resection, while the topside is smooth so as not to damage the femoral condyle.



SURGICAL PREPARATION

Access the knee joint according to the approach that the operating surgeon deems appropriate. Verify that the cruciate ligaments and the contralateral femorotibial and patellofemoral compartments are all undamaged and functional.

Expose the damaged tibial plateau, eliminate meniscal waste and osteophytes. Evaluate the need to carry out a notchplasty if there is a narrowing of the intercondylar notch.

The K-MONO surgical technique, with its reduced extramedullary invasiveness, starts with tibial resection, which must be sufficient to guarantee the articular space of the tibial component.

The tibial guide enables you to make subsequent resections whilst keeping only one pin inserted and at a distance from the joint line. This means that the delicate tibial surface will not be subject to stress, weakening or the risk of sinking of the tibial plateau. The resection block allows a minimally invasive approach.

Blocks are available for performing a Cartier line medial tibial resection (3 and 6 degrees).

Insufficient tibial resection can cause joint deficiency or excessive femoral resection, with the consequent involvement of the patellofemoral joint. The instrumentation provides suitable spacer blocks for correctly assessing the result of tibial resection.

After tibial resection, it is possible to proceed with preparation of the 3CUT or RES femoral component. Both of these different preparations allow you to easily change the size of the chosen component.

The tibial component can be used with both types of femoral component. It is now possible to proceed with the preparation of the tibial component, which will depend on whether it is all-polyethylene (AllPoly) or with a metal back and articular insert (MetalBack). In the case of a cementless tibia, it is recommended to insert a screw into the peg.

The size of the tibial component is independent of the size of the femoral component.

It is possible to carry out the final verification of the most suitable insert even after the definitive femoral and tibial components have been implanted.

IMPLANT VERSIONS

The K-MONO prosthesis is available in different versions, both femoral (3CUT, RES) and tibial (MetalBack, AllPoly). The surgical technique covers all these options.

In the sections on component preparation, these versions are also indicated by their respective logos.

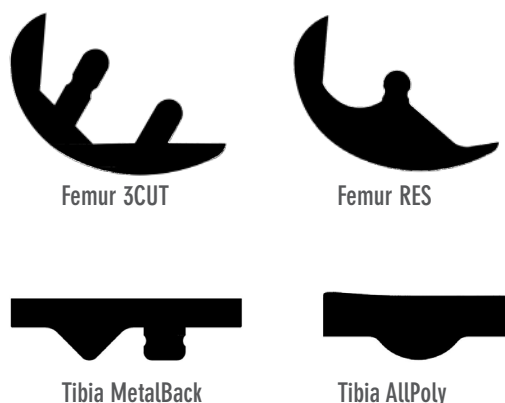

ANATOMICAL COMPONENTS

The 3CUT femoral components and the tibial components are anatomical. In choosing the guides, resection blocks and trial and definitive components make sure the sides are correct:

- RM/LL: Right Medial/Left Lateral
- RL/LM: Right Lateral/Left Medial

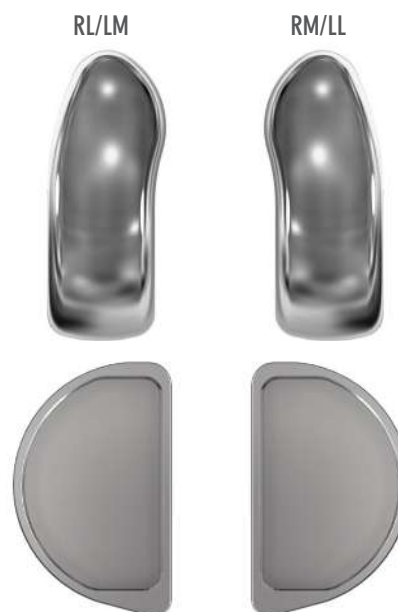

The extra-medullary tibial resection guide is composed of four elements: Proximal Tibial Guide (300114000), the appropriate Tibial Resection Block depending on the side to be operated (RM/LL: 300114002, RL/LM: 300114003), the Tibial Distal Guide (300110122) and the Ankle Clamp (300110133).

Assembly must be carried out before application, positioning the proximal guide towards the part to be worked.

ALIGNMENTS

Place the Ankle Clamp around the ankles and adjust the length of the guide so that the Tibial Resection Block is at roughly the level of the desired cut. The Tibial Stylus 2-4mm (300114001) can already be screwed into the slot in the Tibial Resection Block. The surgeon can select a minimal (tip marked 2mm for 2mm resection) or slightly deeper resection (tip marked 4mm for 4mm resection) depending on the specific conditions. In any case, it will subsequently be possible to check and change the resection level.

Align the tibial resection guide on the proximal tibia with the medial one-third of the tibial tubercle and/or distally with the second metatarsophalangeal bone.

The posterior slope can be adjusted using the Angel Wing (300114132) and by acting on the AP lever of the Distal Tibial Guide. In general, proximal tibial resection should align with the tibia's natural posterior slope.

Lock the Proximal Tibial Guide in position with a Pin 3,2mm x 80mm (300110144). It will however be possible to subsequently correct the mechanical axis in varus-valgus and the resection level. The pin can be inserted into the hole or the slotted hole. In the latter case, the posterior slope can be subsequently corrected and the hole can be used for definitive stabilization of the guide.

The alignment on the frontal varus-valgus mechanical axis can be adjusted by releasing the handle of the Tibial Distal Guide and sliding the guide on the Ankle Clamp in the ML plane.

Tibial Resection Block

(RM/LL: 300114002, RL/LM: 300114003):

- Chosen depending on the side to be operated

Proximal Tibial Guide (300114000):

- Rotate it depending on the side to be operated

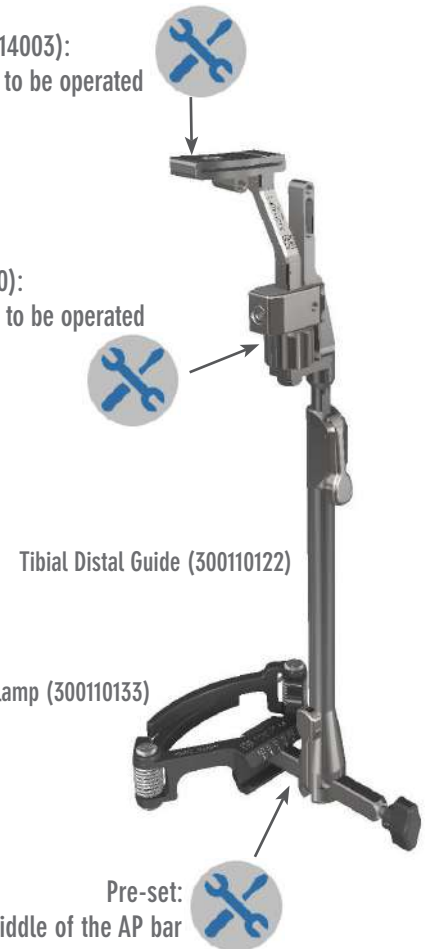

Tibial Stylus 2-4mm
(300114001)



TIBIA: RESECTION

Check that the cut is adequate and, if necessary, change the resection level after removing the Tibial Stylus. Release the mechanism on the side of the Proximal Tibial Guide using the Hex Screwdriver (340085045) and act on the ring nut to micrometrically move the Tibial Resection Block vertically. At the end of the adjustment lock the mechanism.

NOTE: this operation can also be repeated after an insufficient tibial resection. In this case, it won't be necessary to use additional pins, so the delicate tibial surface will not be subject to stress or weakening.

MINIMALLY INVASIVE APPROACH

In the case of minimally invasive incisions, at the end of the adjustments it is possible to block the guide with a pin directly in the Tibial Resection Block. The pin is inserted at a slightly convergent angle and must be removed and repositioned in the case of further resection.

Position the retractors in the instrumentation before performing tibial resections.

SAGITTAL TIBIAL RESECTION

Perform sagittal tibial resection using a reciprocating saw. Keep perpendicular to the Tibial Resection Block, which develops an indicative sign regarding the AP direction of the resection; keep close to the tibial spine to avoid damage to the central pivot.

The blade should not cut too far down, as this results in weakening of the tibia.

The reciprocating blade can be left in place as protection during the subsequent horizontal resection.

- Slot (in the center): allows posterior slope correction
- Hole: stabilization of the guide

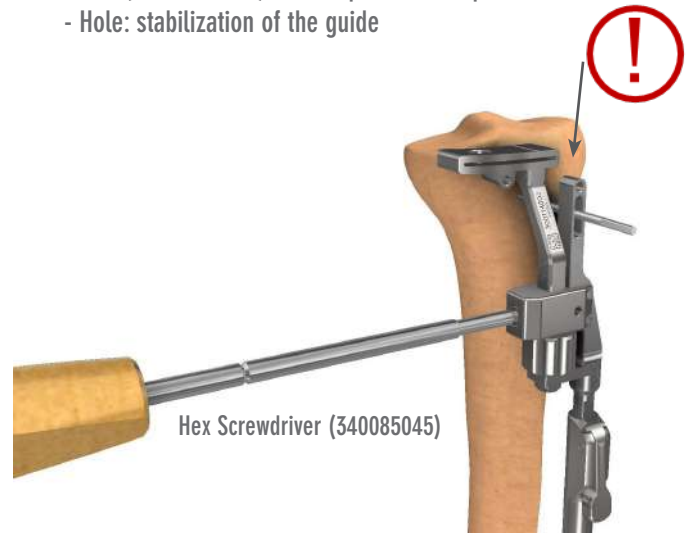

- ! Reciprocating blade:
 - Do not cut too far down
 - Left in place as protection



TRANSVERSE TIBIAL RESECTION

Perform transverse tibial resection using an oscillating saw through the slot in the Tibial Resection Block. The blade should not invade the bone bridge of the cruciate ligaments, as this results in weakening of the tibia.

TIBIAL COMPONENT THICKNESS

Evaluate the thickness of the tibial component, or the need for further resection, using Spacer Block TIB/PE 8÷12mm (300114100÷101). In this phase it is possible to leave the tibial guide in place: just lower or remove the Tibial Resection Block. The spacer blocks simulate the thickness of the overall tibial component (AllPoly or MetalBack + Polyethylene Insert).

Insert the spacer block and evaluate the articulation in flexion. In extension and flexion at 90 degrees the spacer block must be able to be inserted and moved fairly easily and not be tight. Evaluate any soft tissue tension or inequalities in joint spaces. To avoid: tight articulation, deficit in extension, overcorrection of the mechanical axis, in which case choose a thinner insert or perform a further tibial resection.

In order to evaluate the mechanical axis, it is possible to use the Alignment Rod (300110161) together with the Extension Alignment Rod (300114104).

The chosen spacer block determines the thickness of the definitive tibial component.

Remove the tibial guide and the pins.



Extension Alignment Rod (300114104)
+
Alignment Rod (300110161)

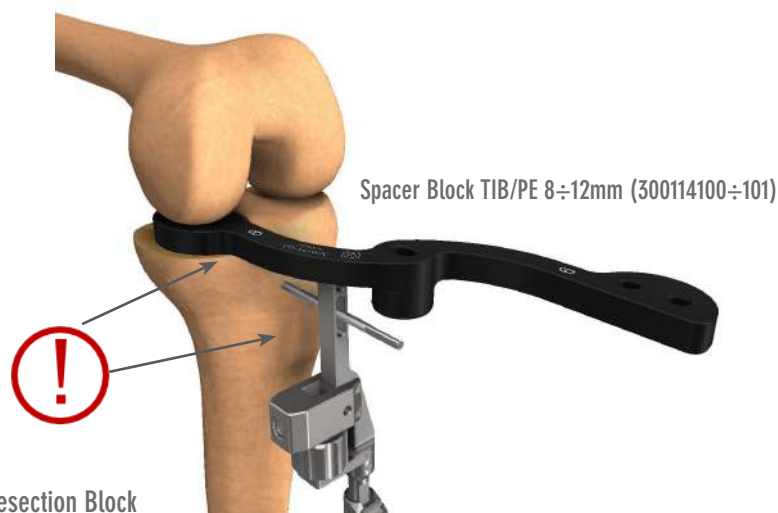

- Leave the tibial guide in place:
just lower or remove the Tibial Resection Block
- The spacer block must be able to be inserted
and moved fairly easily and not be tight

TIBIA: RESECTION

ANTERIOR FEMORAL LIMIT

Bring the knee into full extension and use a cautery to mark the anterior edge of the spacer block on the femoral condyle.

In this way the upper limit of the femoral component is highlighted, thus avoiding potential conflict with the patellofemoral joint.

Upper limit of the femoral component



TIBIAL COMPONENT SIZING

Obtain an initial indication of the tibial measurement by comparing the resected plateau with the Tibial Sizer 1÷6 (300114010÷012) and then placing it directly on the resected surface. By inserting the Tibial Ruler (300114013) it is possible to palpate the posterior limit and check the front limit.

The ML size is decisive in the final choice. Avoid overhanging of the tibial component in both AP and ML.

If necessary, clean up the sagittal or transverse resection using the Tibial Rasp (300114004), keeping the smooth side towards the femur.



Tibial Sizer 1÷6 (300114010÷012)

Tibial Rasp (300114004)
- Smooth side towards the femur



Tibial Ruler (300114013)
- Posterior limit
- AP dimension

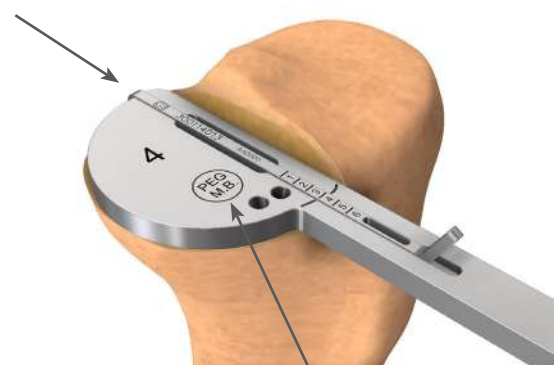

MetalBack Tibia
- Peg position



Assemble the Distal Resection Block Modular F3C (300114301) with the Plate Tibial Thickness 8÷12mm (300114105÷108) chosen according to the determined thickness of the tibial component. The distal femoral resection will be equal to the thickness of the femoral component: 6.75 mm.

DISTAL BONE DEFECTS

If a distal femoral defect is present, a shallower resection can be performed. In this case, the Defect Plate Distal 2mm F3C (300114300) must also be mounted to resect 2mm less deep (resection: 4.75mm).

NOTE: In the OPTION NATURAL INSTRUMENT tray (300114404) there are additional plates for defects: Defect Plate Distal 1/3mm F3C (300114305÷306) to resect, respectively, 1mm less (resection: 5.75mm) and 3mm less (resection: 3.75mm).

Just in case of distal femoral defect:
Defect Plate Distal 2mm F3C (300114300)

OPTION NATURAL INSTRUMENT
Defect Plate Distal 1/3mm F3C (300114305÷306)

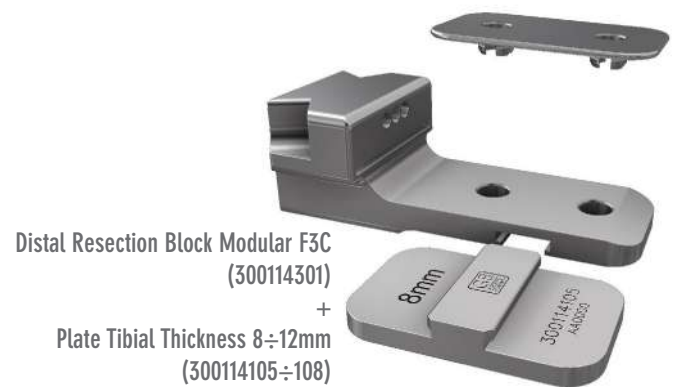

DISTAL RESECTION

Bring the knee into full extension but avoid hyperextension! The knee should remain between 0 and 5 degrees of flexion. Make sure there are no retractors affecting the ligament balance. Insert the assembly in the knee. The guide enables correct positioning in the ML plane. It is possible to facilitate positioning and stability by screwing in the Universal Handle/Pin Extractor (300110281). Fix the distal resection guide with a pin. Perform the resection through the slot. Remove the pin and the guide.

If necessary, bring the knee into deep flexion and finish the distal resection in the extreme posterior area. Eliminate any posterior osteophytes that could limit extension.



Knee between 0 and 5 degrees of flexion
Avoid hyperextension!

If necessary:
- Knee into deep flexion
- Finish the distal resection in the extreme posterior area



Universal Handle/Pin Extractor (300110281)





EXTENSION GAP

Check the gap and ligament balance in extension. Assemble the Spacer Block TIB/PE 8÷12mm (300114100÷101), chosen according to the thickness of the tibial component previously determined, with the femoral part Spacer Block F3C (300114302).

Insert the spacer block in extension and evaluate any tension in the soft tissues. To be avoided: tight articulation, deficit in extension, overcorrection of the mechanical axis.

In order to evaluate the mechanical axis, it is possible to use the Alignment Rod (300110161) together with the Extension Alignment Rod (300114104).

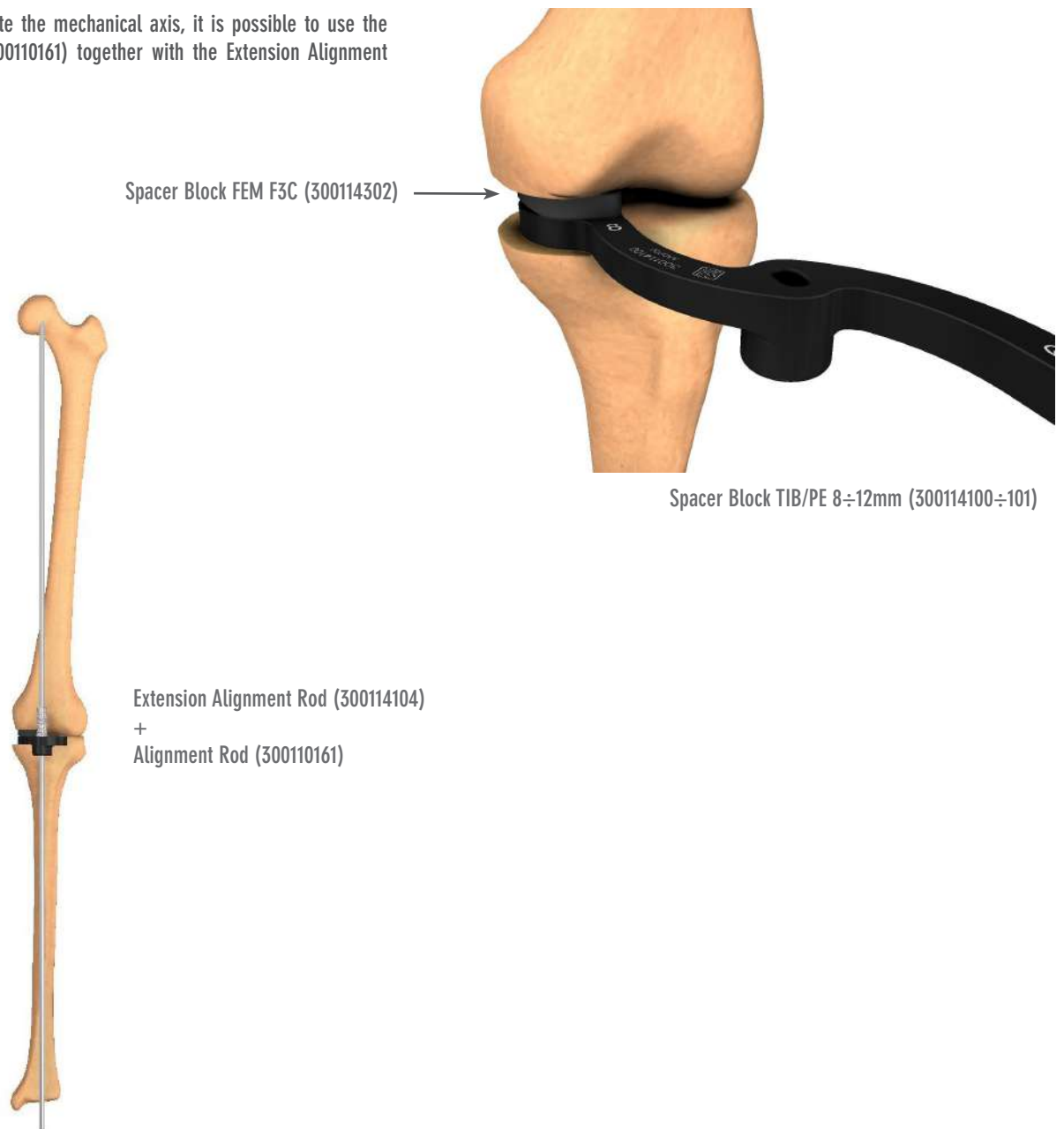



SIZING AND FINAL PREPARATION

Determine the size and correct ML positioning of the femoral component with the Resection Block 2in1 F3C RM/LL RL/LM 1÷6 (300114311÷326) in accordance with the side to be operated. The blocks faithfully replicate the distal shape of the femoral component and must be perfectly flush with the distal resection. Their front edge must remain about 2mm below the previously traced upper limit.

The size of the femoral component is independent of that of the tibial component.

If in doubt, choose a smaller femoral size, as this will allow an easy transition to a bigger one.

POSITIONING IN ML

The blocks can be positioned:

- with the knee in deep flexion, directly on the femoral condyle
- with the knee at 90 degrees of flexion, assembling them with the Plate Tibial Thickness 8÷12mm (300114105÷108) chosen according to the determined thickness of the tibial component

It is possible to facilitate positioning and stability by screwing in the Universal Handle/Pin Extractor (300110281). Identify the optimal positioning in ML, indicatively:

- medial condyle: position the component with the inner edge as close as possible to the intercondylar space without invading it;
- lateral condyle: position the component centrally with respect to the tibial plateau.

Secure the resection block with one or two short pins.

Front edge below the upper limit
(about 2mm)

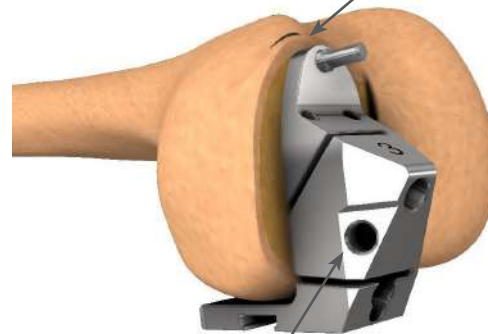

Hole for Universal Handle/Pin Extractor
(300110281)

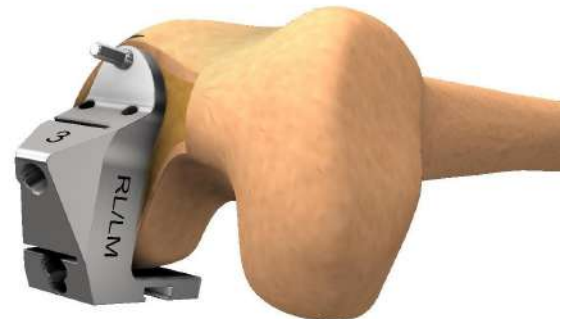

BONE REFERENCE

Resection Block 2in1 F3C RM/LL RL/LM 1÷6
(300114311÷326)

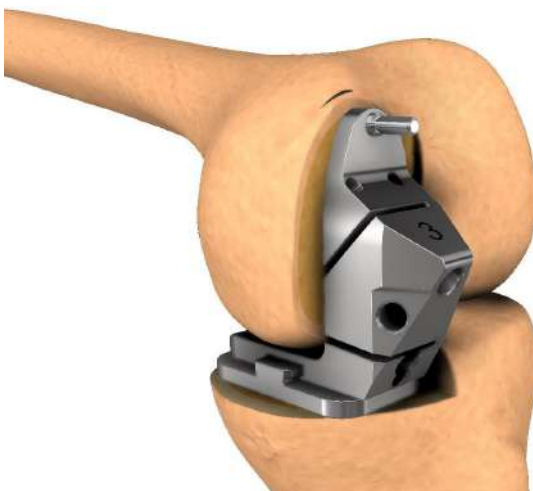

FLEXION REFERENCE

Resection Block 2in1 F3C RM/LL RL/LM 1÷6 (300114311÷326)
+
Plate Tibial Thickness 8÷12mm (300114105÷108)



FEMORAL PREPARATION

Drill the holes for the two femoral pegs using the Drill Femoral Pegs Diam 6mm (300114120) inserted up to the stop.
 Perform the posterior and oblique resections using the narrow oscillating saw. Pay particular attention because the resection slots are open on one side!
 Remove pins and resection block.

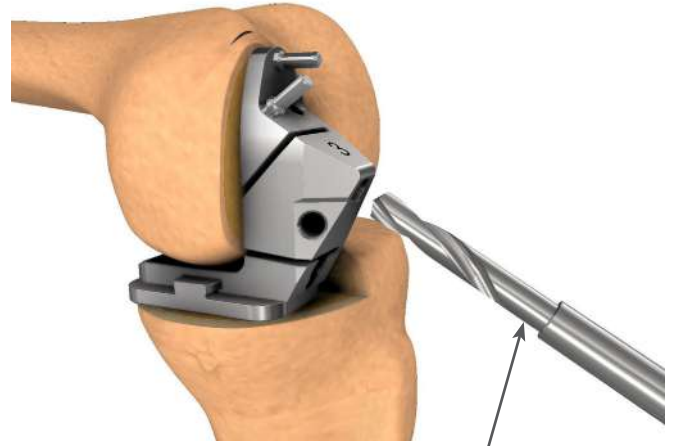

Drill Femoral Peg Diam 6mm (300114120)

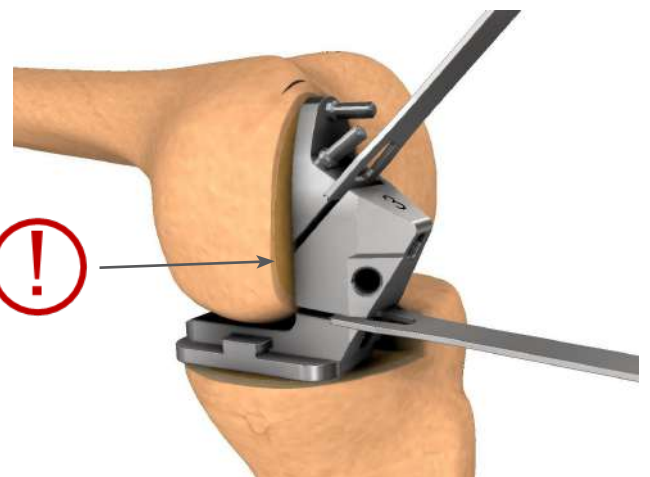

Resection slots open on one side!

FEMORAL SIZE CHANGE

All the 3CUT femoral components have the same implant thickness (6.75mm), distal and posterior resections and the lower hole for the peg (on the chamfer resection).
 Changing the size therefore changes the chamfer resection, the upper hole for the peg (on the distal resection) and the dimensions in AP and ML. The centre-to-centre distance between the upper peg holes of one size and the next is 1.5mm.

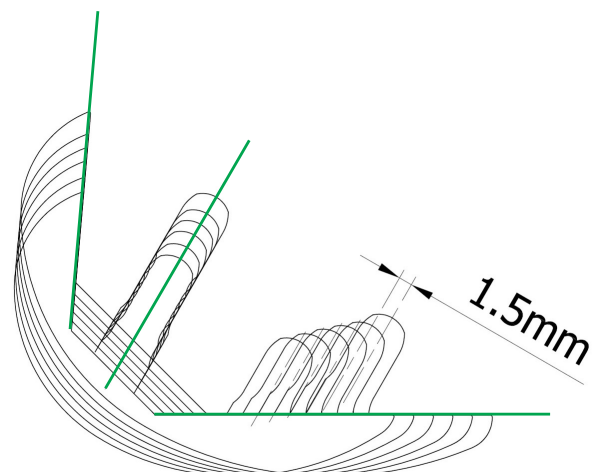



SIZING AND PREPARATION

Determine the size and correct ML positioning of the femoral component with the Resection Block FRS 1÷6 (300114211÷216). The blocks faithfully replicate the distal shape of the femoral component and must be used as a reference for cartilage removal. Their front edge must remain about 2mm below the previously traced upper limit.

Determine the contours of the distal area of the femur from which to remove the cartilage and proceed using an oscillating saw, preferably with a short blade. Indicatively, remove from 2 to 4mm. Proceed sequentially, frequently checking the correspondence between the curved condylar femoral geometry that is being modeled and the curvature of the chosen Resection Block. By the end, the two surfaces must match.

The size of the femoral component is independent of that of the tibial component.
If in doubt, choose a smaller femoral size, as this will allow an easy transition to a bigger one.

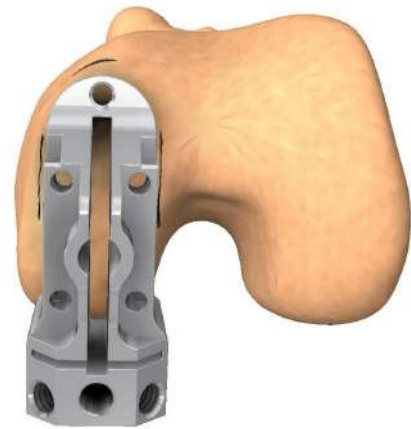

Resection Block FRS 1÷6 (300114211÷216)

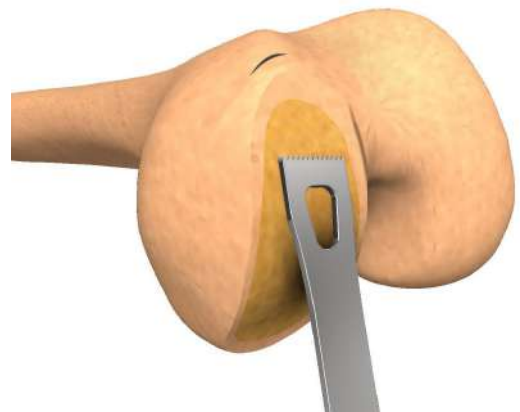

At this stage, mark the depth limit for the femoral fin (FIN DEPTH) indicated on the Resection Block FRS on the oscillating saw blade. This will prevent the creation of an excessive space for the fin in the subsequent preparation phase.

Front edge below the upper limit (about 2mm) 

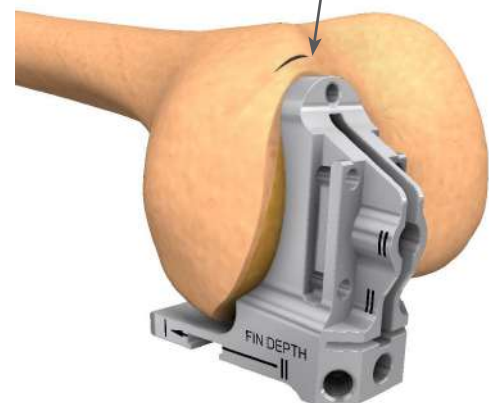



POSITIONING IN ML

Assemble the Resection Block with the Plate Tibial Thickness 8÷12mm (300114105÷108) chosen according to the determined thickness of the tibial component.

Flex the knee to 90 degrees and insert the assembly. It is possible to facilitate positioning and stability by screwing in the Universal Handle/Pin Extractor (300110281).

Indicatively identify the optimal positioning in ML:

- medial condyle: position the component with the inner edge as close as possible to the intercondylar space without invading it;
- lateral condyle: position the component centrally with respect to the tibial plateau.

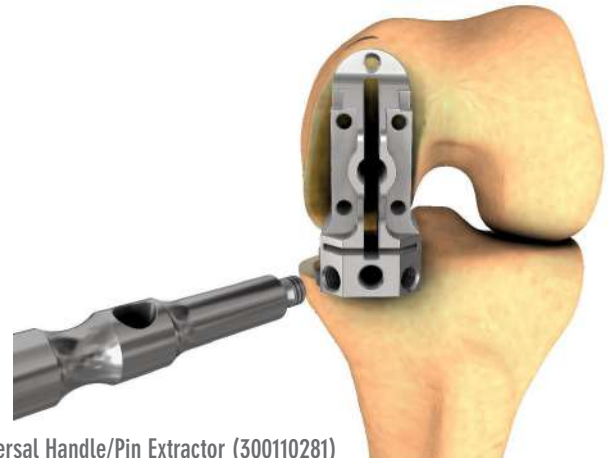

Universal Handle/Pin Extractor (300110281)

FRONTAL FEMORAL ALIGNMENT

On the resection block it is possible to insert the Support EM Flexion Rod FRS (300114200) and the Alignment Rod (300110161) in line with the center of the knee. Check that the proximal end of the extramedullary rod is above the center of the femoral head (femoral mechanical axis). This alignment differs from the anatomical slope of the femoral condyles.

Fix the resection block with one long pin in the central upper hole and a short one on the side; remove the support with the rod.

Support EM Flexion Rod FRS (300114200)
- Choose the hole in the center of the knee

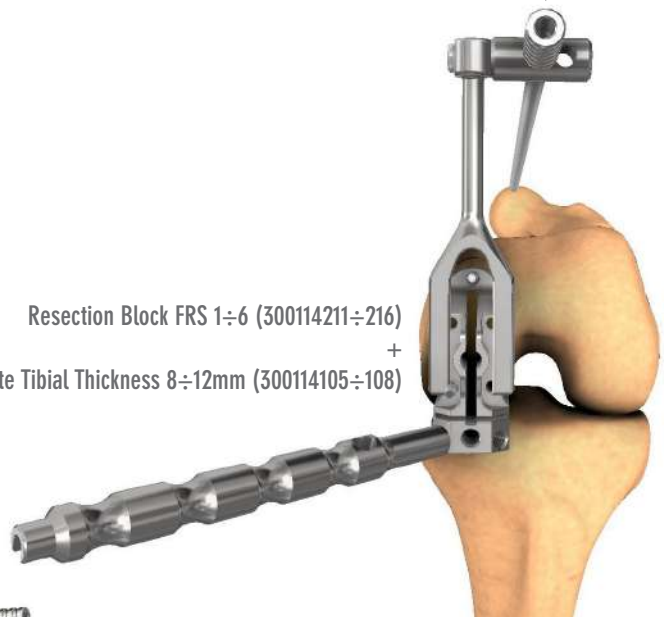

Resection Block FRS 1÷6 (300114211÷216)
+
Plate Tibial Thickness 8÷12mm (300114105÷108)

Alignment Rod (300110161)





FEMORAL PREPARATION

Perform central resection for the femoral component reinforcement fin. Use the oscillating saw blade with the previously marked (FIN DEPTH) on it and insert it following the profile of the resection block. This profile mirrors that of the fin, thus avoiding excessive penetration.

Drill the femoral peg hole using the Drill Femoral Peg Diam 6mm (300114120) inserted up to the stop and lastly the posterior resection. Remove the pins and the resection block.

For a better housing of the femoral component it might be appropriate to clean up the edge between the distal surface and the posterior resection; use Luer ossivorous pliers, a small chisel or a rasp.

The mark on the blade follows the profile

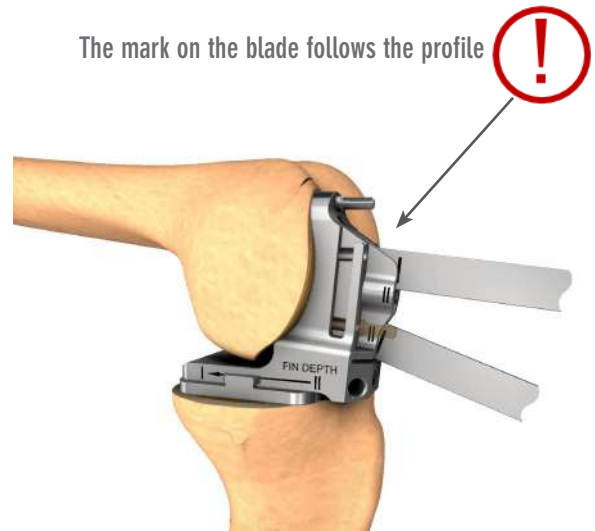

Drill Femoral Peg Diam 6mm (300114120)

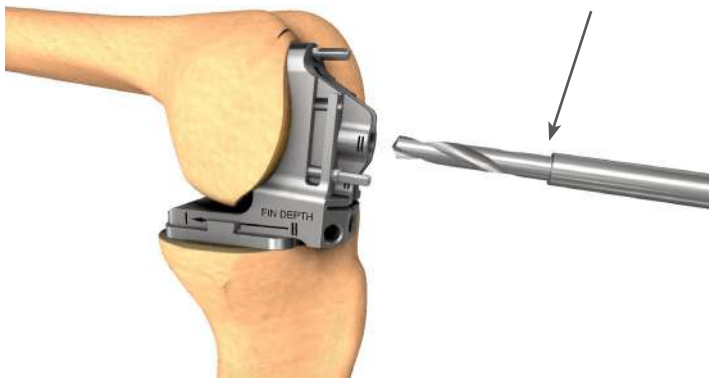

If necessary, clean up the edge between the distal and posterior surfaces



FEMORAL SIZE CHANGE

All the RES femoral components have the same implant thicknesses (distal: 4mm; posterior: 6.75mm), posterior resection and peg hole for small (1, 2, 3) and large sizes (4, 5, 6).

Changing the size therefore changes the distal curvature, the dimensions in AP and ML and the peg hole between the small (1, 2, 3) and large sizes (4, 5, 6). The peg hole center-to-center distance between the small and large sizes is 4.5mm.

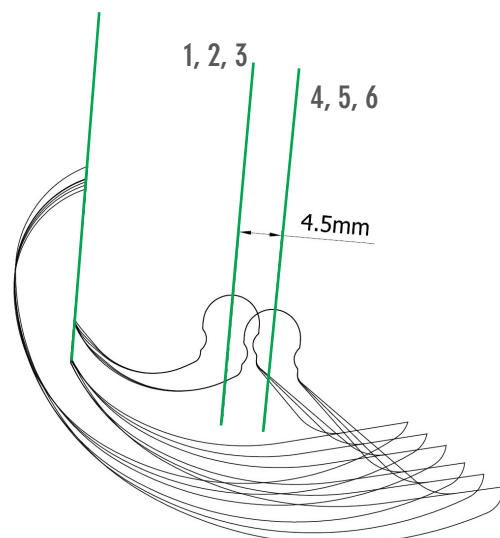

FLEXION GAP

Mount the Femoral Positioner (300114122) on the trial femur component having chosen between the Trial Femur F3C RM/LL RL/LM 1÷6 (300114331÷346) of the desired size and side to operate and the Trial Femur FRS 1÷6 (300114221÷226).

Place the trial femur on the condyle and impact it lightly. Unclip the Femoral Positioner and complete the housing using the Femoral Impactor (300114121). Prefer an impacting point towards the rear, avoiding the front edge. Check there is perfect adherence between the trial and the bone surface, and note any mid-lateral protrusions.

Introduce the Spacer Block TIB/PE 8÷12mm (300114100÷101), chosen on the basis of the previously determined thickness of the tibial component and check articular kinematics, gaps and ligament balance, the ML position of the femoral component and any tension in the soft tissues. To be avoided: tight articulation, deficit in extension and overcorrection of the mechanical axis.

In order to evaluate the mechanical axis, it is possible to use the Alignment Rod (300110161) together with the Extension Alignment Rod (300114104).

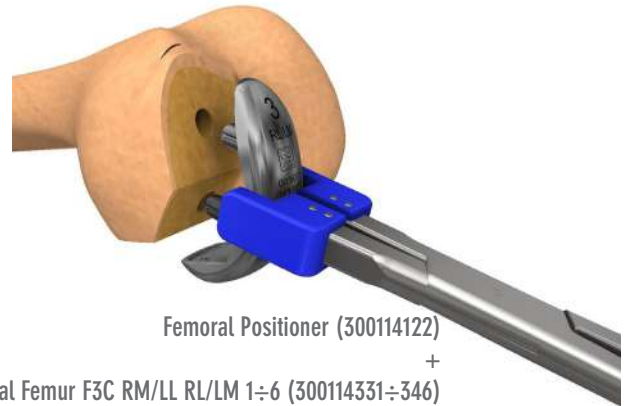

Femoral Positioner (300114122)
+
Trial Femur F3C RM/LL RL/LM 1÷6 (300114331÷346)
Trial Femur FRS 1÷6 (300114221÷226)

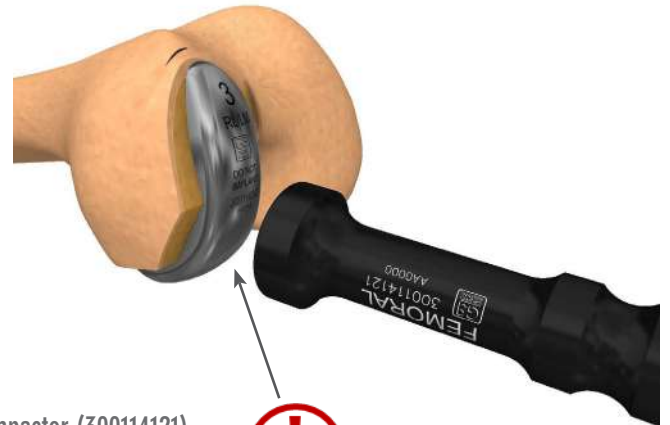

Femoral Impactor (300114121)
- Impacting point towards the rear

ALLPOLY TIBIA TRIAL REDUCTION

The evaluation described above is valid as a trial reduction in the case of an AllPoly tibial component implant. For these components, in fact, there is no specific trial component, so the spacer block is used.

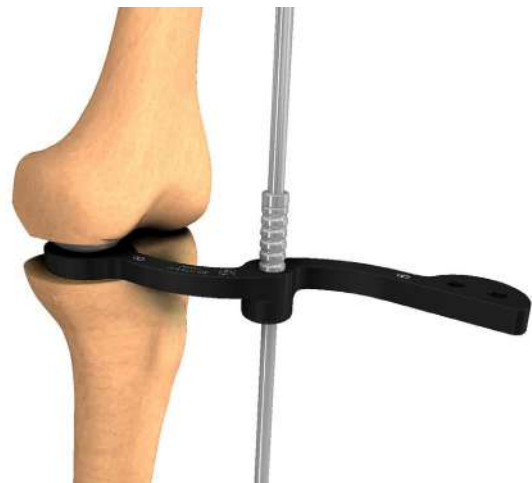
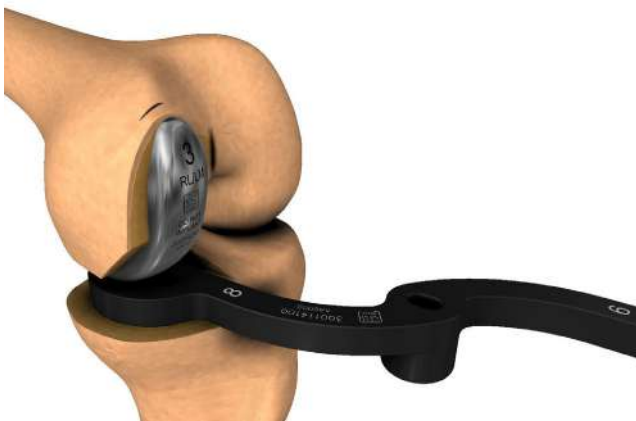

PREPARATION

Introduce the previously selected Tibial Sizer 1÷6 (300114010÷12). Check for correct coverage of the plateau and the absence of protrusions with respect to the bone.

Incorrect vertical resection may compromise the subsequent insertion of the tibial component. If necessary, clean up the sagittal or transverse resection using the Tibial Rasp (300114004), keeping the smooth side towards the femur.

Stabilize the Tibial Sizer with a Headed Pin For Baseplate (300110197) fully inserted into the front hole.

Prepare the site for the tibial fin beforehand by sinking the Chisel AllPoly (300114020) into the slot on the sizer by a few millimeters. This operation is necessary as direct use of the broach could cause a fracture in the tibial plateau.

Finish the preparation by impacting the Broach AllPoly Fin (300114019) into the slot, taking care to keep it perpendicular to the tibial plateau.

Remove the pin, with the Universal Handle/Pin Extractor (300110281), and the tibial sizer.

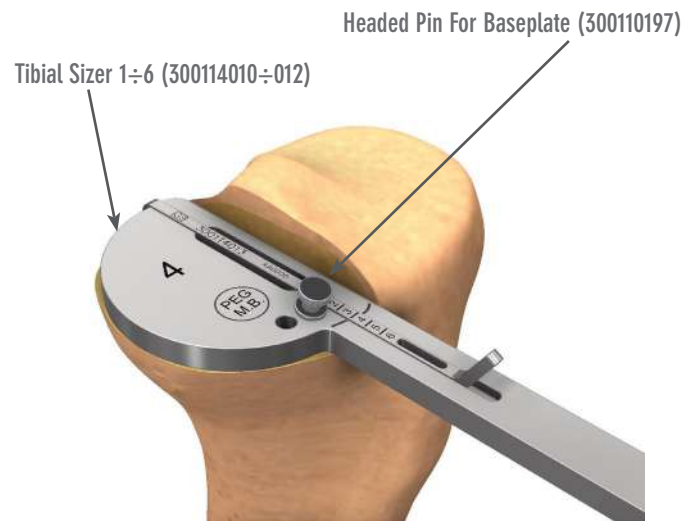

Chisel AllPoly (300114020)
- Prepare the site!



Broach AllPoly Fin (300114019)





PREPARATION

Mount the Nipper Trial Tibia MetBack (300114040) on the trial tibia component: Trial Tibia MetBack RM/LL RL/LM 1÷6 (300114021÷036) of the previously selected size and side to operate.

The trial tibia component has an enlarged shoulder towards the inner part in order to perfectly verify the quality of the vertical resection. Incorrect vertical resection may compromise subsequent insertion of the polyethylene insert. If necessary, clean up the sagittal or transverse resection using the Tibial Rasp (300114004), keeping the smooth side towards the femur.

Introduce the trial tibia component making sure there is correct coverage of the plateau and no overhang with respect to the bone. The outline of the anti-rotational fin is set into the lower surface, which will thus be prepared in this phase.

Impact the trial component with the Tibial Impactor (300114016): avoid applying excessive force so as not to compromise correct positioning.

Check that the component is perfectly flush with the bone resection, unhook the nipper and stabilize the component with a short pin or headad pin in the front hole.

Drill the hole for the tibial peg using the Drill Tibial Peg (300114015) kept perpendicular to the tibial plateau.

Keep the component in place for the purpose of the trial reduction.

Nipper Trial Tibia MetBack (300114040)

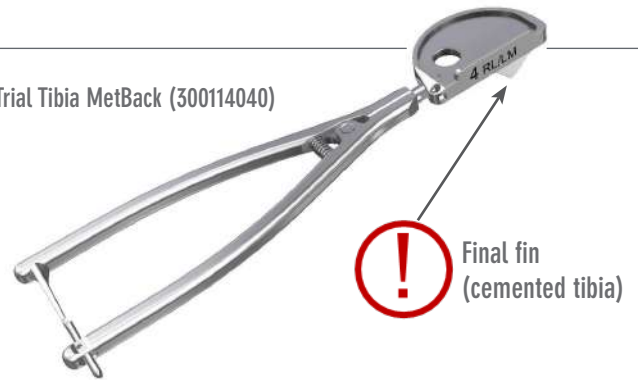

Trial Tibia MetBack RM/LL RL/LM 1÷6 (300114021÷036)

- Enlarged shoulder: vertical resection check



Drill Tibial Peg (300114015)

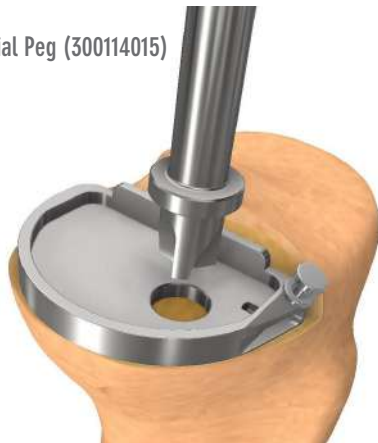

Tibial Impactor (300114016)

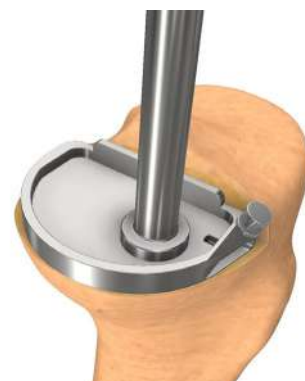



TIBIA ALLPOLY

Please, refer to FLEXION GAP chapter

TIBIA METALBACK

Position the Trial Insert MetalBack 8÷12mm 1÷6 (300114041÷076) in the trial tibial component selected as follows:

- size equal to that of the tibial component
- thickness equal to that of the spacer block

Each insert can be used for both sides: the ANT label identifies the front of the two sides.

FEMUR

Mount the Femoral Positioner (300114122) on the trial femur component having chosen between the Trial Femur F3C RM/LL RL/LM 1÷6 (300114331÷346) of the desired size and side to operate and the Trial Femur FRS 1÷6 (300114221÷226).

Place the trial femur on the condyle and impact it lightly. Unclip the Femoral Positioner and complete the housing using the Femoral Impactor (300114121). Prefer an impacting point towards the rear, avoiding the front edge.

Check that the trial is perfectly flush with the bone surface and that there are no medial-lateral overhangs.

Evaluate the stability of the joint in extension and flexion. The knee should be able to fully extend. The flexion test must be performed with the knee flexed at 90°. Optimum stability is achieved when the medial and lateral opening is similar to that of a normal knee under the stress of the varus-valgus forces.

Trial Insert MetalBack 8÷12mm 1÷6 (300114041÷076)

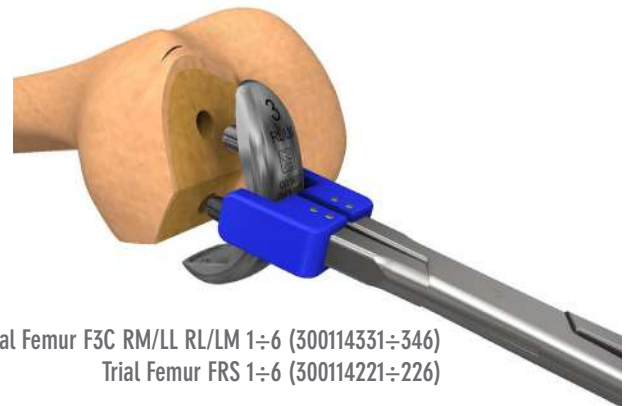
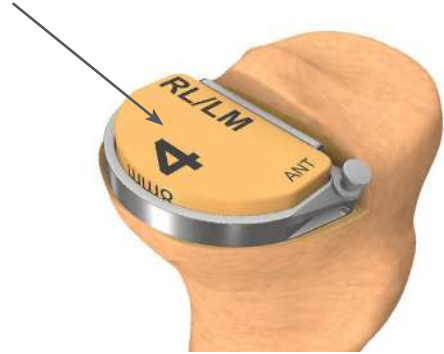

Trial Femur F3C RM/LL RL/LM 1÷6 (300114331÷346)
Trial Femur FRS 1÷6 (300114221÷226)



DO NOT!

- Tight articulation
- Extension deficit
- Mechanical axis overcorrection

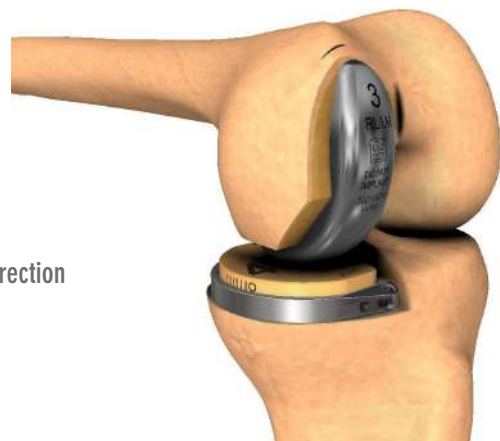

DEFINITIVE IMPLANTS

Carefully choose the definitive components. Pay attention to the size and side to be operated.

The color code on the packaging of the MetalBack tibial component and the articular inserts must match the color of the trial insert defined during the trial reduction. The size of the polyethylene insert must be the same as that of the tibial component. The sizes of the femoral and tibial components are independent of each other.

If cemented components are used, proceed with the operating surgeon's preferred cementing technique. A few small diameter holes may be drilled in the resected bone beds to improve cement anchoring. Apply the cement with great care.

If uncemented components are used, refer also to the section OPTION: SCREW, especially regarding insertion of the screw in the tibial component.

Thoroughly clean the surfaces that will host the implants, for example with a pulsed wash, and position the joint in deep flexion.

TIBIA ALLPOLY

Assemble the Modular Impactor Tib/AllPoly (300114018) with the purple Support Modular Impactor AllPoly (300114006).

Insert the AllPoly tibial component (120704401/X/E-486/X/E) using the vertical tibial wall and the space created for the fin as landmarks. Press the component fully in and complete the positioning with the modular impactor.

Check that the component is correctly positioned on the tibial surface. Carefully remove all excess cement, especially in the posterior area.



Color code



Modular Impactor Tib/AllPoly (300114018)

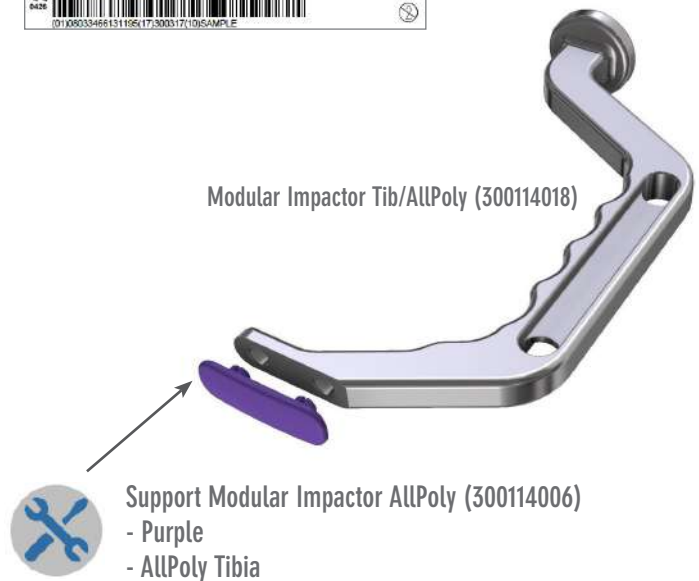

Support Modular Impactor AllPoly (300114006)
- Purple
- AllPoly Tibia



Definitive components: AllPoly Tibia



UNCEMENTED METALBACK TIBIA

Before proceeding with the implant, as described below, it is important to remember that:

- for the final insertion of the screw, it's necessary to remove the cap from the inside of the tibial peg using the Hex Screwdriver (340085045); Place a drop of blood on the tip of the screwdriver prior to attaching it over the locking cap; this may improve retention and help hold the cap on the tip of the screwdriver, making it easier to remove.
- the definitive anti-rotational fin is larger than the one created with the trial component, so it is advisable to proceed progressively with the intensity of the impacting and work from the rear towards the front.

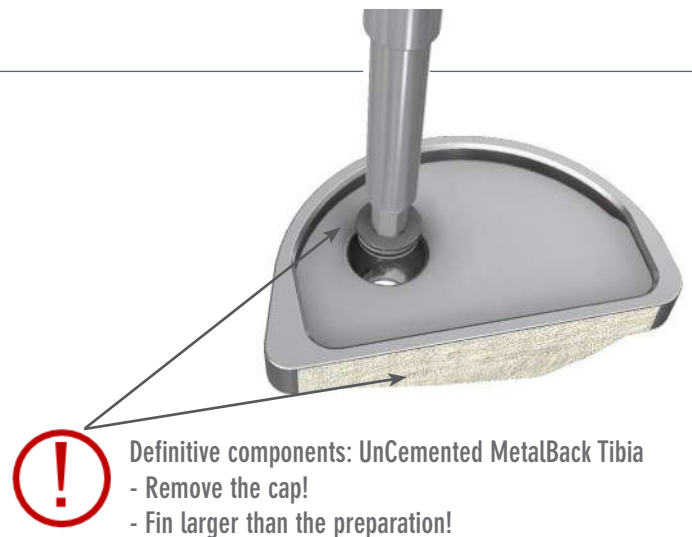

METALBACK TIBIA

Assemble the Modular Impactor Tib/AllPoly (300114018) with the brown Support Modular Tibia Impactor (300114005). Insert the MetalBack tibial component (120704301/T÷326/T; 120704311T÷336T) using the vertical tibial wall and the spaces created for the anti-rotational fin and the peg as landmarks.

Press the component fully in and complete the positioning with the modular impactor.

Alternatively, it is possible to use the Tibial Impactor (300114016).



Support Modular Tibia Impactor (300114005)
 - Brown
 - MetalBack Tibia

Definitive components: Tibia MetalBack



Check that the component is correctly positioned on the tibial surface.

- Cemented components: carefully remove all the excess cement, especially in the posterior area.
- Uncemented components: proceed with the insertion of a screw in the hole through the peg (see section OPTION: SCREW).

Thoroughly clean the upper surface of the tibial component.

Introduce the insert (120704201/X/E÷286/X/E) onto the tibial plateau keeping it tilted and engage the slot on the posterior side. Now lay the front part down. Place the groove of the Tibial Impactor (300114016) against the insert and fit the latter into the plateau by exerting force obliquely on the front edge of the insert.

Definitive components: Insert

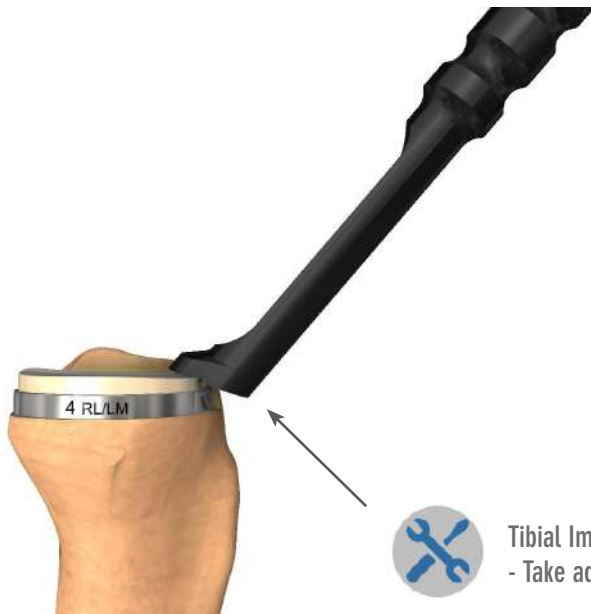
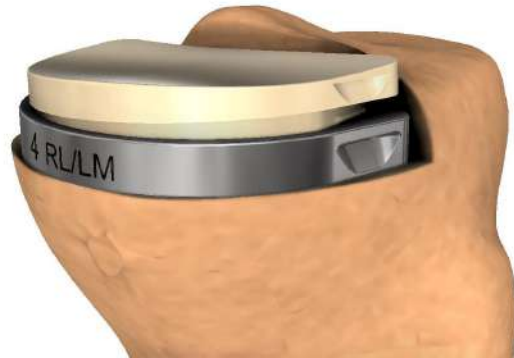

Tibial Impactor (300114016)
- Take advantage of the groove

FEMUR

Assemble the Femoral Positioner (300114122) with the femoral component (120704101/A÷126/A; 120704151/A÷166/A; 120704141/A÷146/A). Bring the joint into deep flexion. Position the femoral component on the condyle using the two holes for the pegs (3CUT) or the hole for the peg and the slot for the fin (RES) as landmarks and impact it slightly.

Flex the knee to about 90 degrees, release the Positioner and complete the housing using the Femoral Impactor (300114121). Prefer an impacting point towards the rear, avoiding the front edge. Check that the component is perfectly flush with the bone surface.

If cemented components are used, carefully remove all excess cement.

Adjust the components by bringing the knee into full extension or slight flexion.

When using cemented components, leave the knee in extension during the cement hardening phase.

Check for and remove any excess cement residues.

Evaluate joint movement and stability in the range of motion. Irrigate and thoroughly clean the joint of all residues. Proceed with suturing and closure as per surgeon preference.

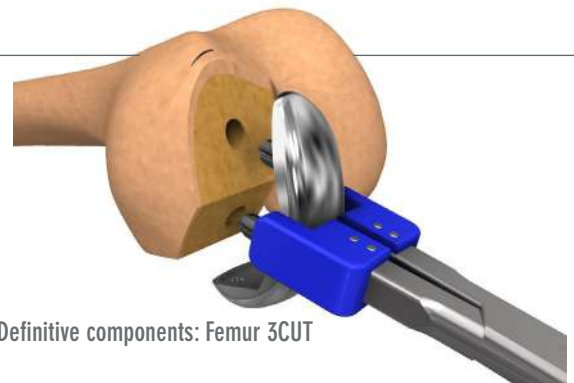

Definitive components: Femur 3CUT

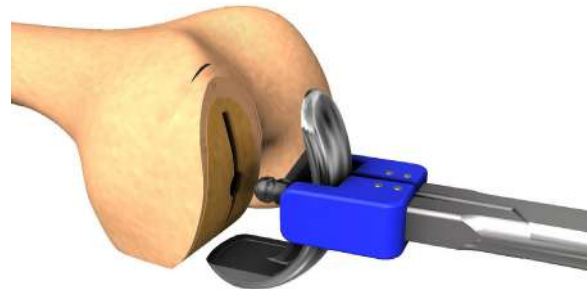

Definitive components: Femur RES

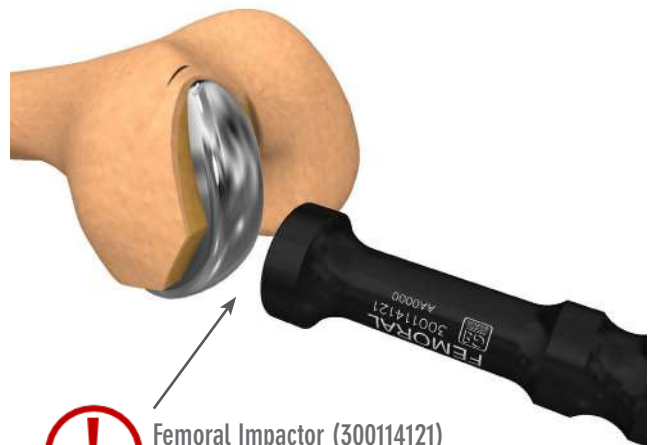

Femoral Impactor (300114121)
- Impacting point towards the rear



TIBIA ALLPOLY



TIBIA METALBACK



FINAL TRIAL WITH TRIAL INSERT

Where the MetalBack tibial component is used, it is possible to evaluate the optimum thickness of the polyethylene insert, using the trial inserts, even after having implanted the definitive femoral and tibial components.

Position the appropriately sized Trial Insert MetalBack 8÷12mm 1÷6 (300114041÷076) in the definitive tibial component. All the inserts can be used on both sides: the ANT label identifies the front of the two sides.

After checking the stability of the joint in extension and flexion and choosing the most suitable implant, remove the trial insert and proceed with the insertion of the definitive one as described in the DEFINITIVE IMPLANTS section (under "MetalBack Tibia").

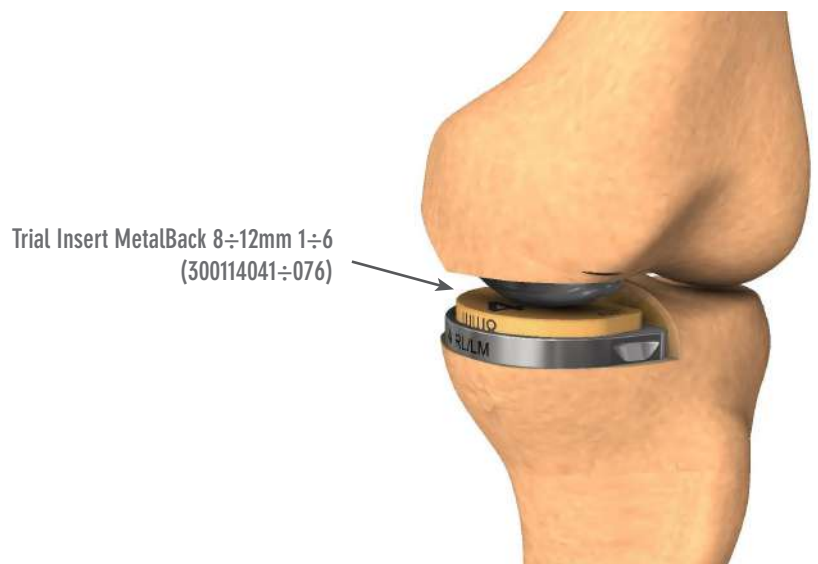
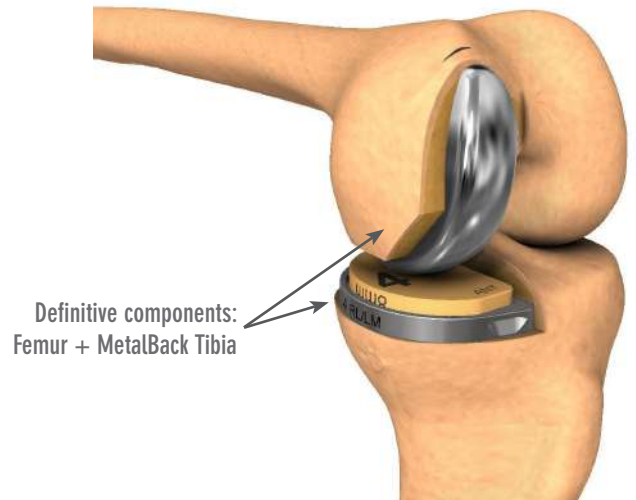

CARTIER MEDIAL TIBIAL RESECTION

The optional instrumentation OPTION NATURAL INSTRUMENT (300114404) has resection blocks for performing the Cartier Line medial tibial resection. There is a choice of two angles: 3 and 6 degrees.

Select the appropriate Tibial Resection Block RM Cartier RM/LM 3/6th (RM 3/6°: 300114080/081; LM 3/6°: 300114082/083) depending on the angle chosen and the side to operate.

Proceed with the assembly of the guide as described the section on TIBIA: RESECTION above.

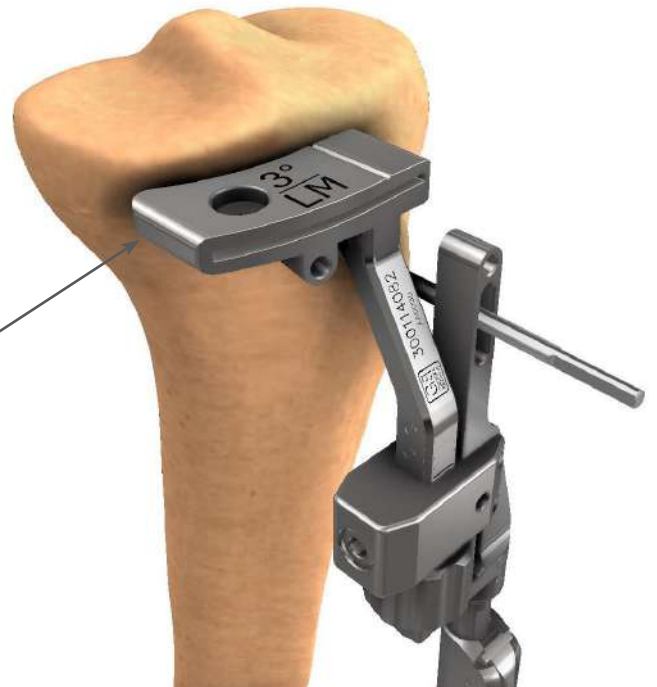

Tibial Resection Block RM Cartier RM/LM 3/6°
(RM 3/6°: 300114080/081; LM 3/6°: 300114082/083)
- Only for MEDIAL side!





UNCEMENTED TIBIA

The optional instrumentation OPTION NATURAL INSTRUMENT (300114404) has instruments for inserting a screw in the peg of the cementless tibial component.

Make sure you have removed the plugging cap from the peg of the tibial component.

After implanting the tibial component, place the Drillguide 3,2 Screw UnCemented 3.2 (300114090) in the screw seat inside the peg. Drill with the Drill Bit Diam 3.2 mm L. 130 mm (300114091) in the postero-median direction. The system allows for a tilt of up to 10° with respect to the vertical.

Leave the Drillguide in place and, using the Drill Bit, assess the depth reached. Make a note of this length and determine the length of the screw by comparing it with the graduated scale on the handle of the Drillguide.

Drillguide 3,2 Screw UnCemented 3.2 (300114090)
+ Drill Bit Diam 3.2 mm L. 130 mm (300114091)

- Direction: postero-median
- Tilt: up to 10° with respect to the vertical

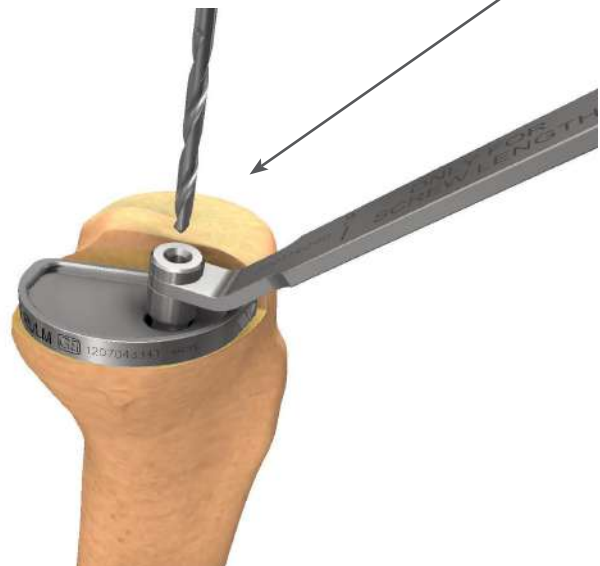

Screw length measurement: Drillguide in place





Select a screw from 25 to 50mm long (120704502÷507) and attach it to the Screw Holder (110381681). Proceed with screwing using the Hex Screwdriver (340085045).



SYNOPTIC IMPLANTS TABLE

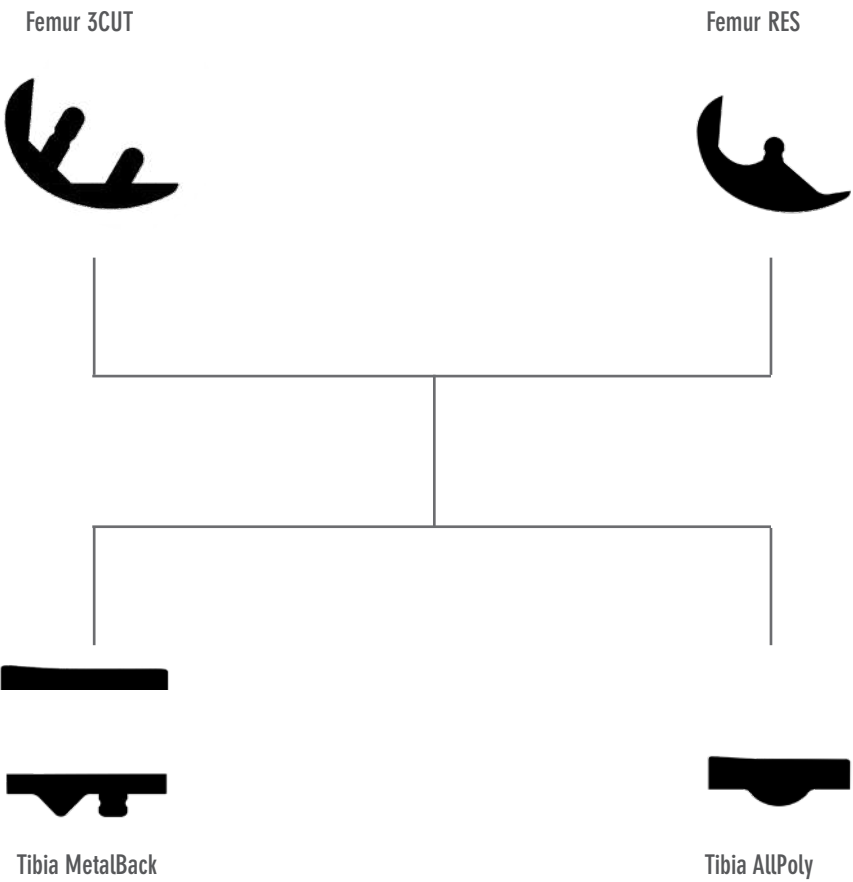

SYNOPTIC SIZING TABLE

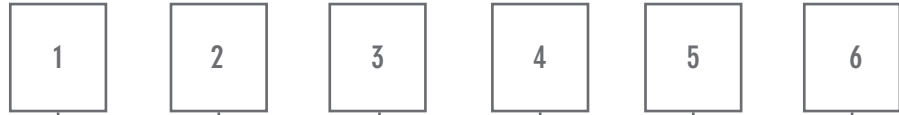

Screw: UnCemented Tibia
L: 25, 30, 35, 40, 45, 50mm

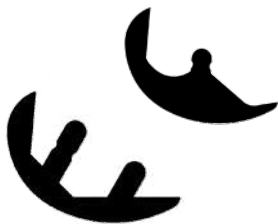

Femur 3CUT Cemented / Allergy



Ref.	DESCRIPTION	ALLERGY
120704101	K-MONO Femur 3CUT RM/LL 1	120704101A
120704102	K-MONO Femur 3CUT RM/LL 2	120704102A
120704103	K-MONO Femur 3CUT RM/LL 3	120704103A
120704104	K-MONO Femur 3CUT RM/LL 4	120704104A
120704105	K-MONO Femur 3CUT RM/LL 5	120704105A
120704106	K-MONO Femur 3CUT RM/LL 6	120704106A
120704121	K-MONO Femur 3CUT RL/LM 1	120704121A
120704122	K-MONO Femur 3CUT RL/LM 2	120704122A
120704123	K-MONO Femur 3CUT RL/LM 3	120704123A
120704124	K-MONO Femur 3CUT RL/LM 4	120704124A
120704125	K-MONO Femur 3CUT RL/LM 5	120704125A
120704126	K-MONO Femur 3CUT RL/LM 6	120704126A

Femur 3CUT UnCemented



Ref.	DESCRIPTION
120704151	K-MONO Femur 3CUT UnCem RM/LL 1
120704152	K-MONO Femur 3CUT UnCem RM/LL 2
120704153	K-MONO Femur 3CUT UnCem RM/LL 3
120704154	K-MONO Femur 3CUT UnCem RM/LL 4
120704155	K-MONO Femur 3CUT UnCem RM/LL 5
120704156	K-MONO Femur 3CUT UnCem RM/LL 6
120704161	K-MONO Femur 3CUT UnCem RL/LM 1
120704162	K-MONO Femur 3CUT UnCem RL/LM 2
120704163	K-MONO Femur 3CUT UnCem RL/LM 3
120704164	K-MONO Femur 3CUT UnCem RL/LM 4
120704165	K-MONO Femur 3CUT UnCem RL/LM 5
120704166	K-MONO Femur 3CUT UnCem RL/LM 6

Femur RES Cemented / Allergy



Ref.	DESCRIPTION	ALLERGY
120704141	K-MONO Femur RES 1	120704141A
120704142	K-MONO Femur RES 2	120704142A
120704143	K-MONO Femur RES 3	120704143A
120704144	K-MONO Femur RES 4	120704144A
120704145	K-MONO Femur RES 5	120704145A
120704146	K-MONO Femur RES 6	120704146A

Tibia MetalBack Cemented CoCr



Ref.	DESCRIPTION
120704301	K-MONO Tibia MetalBack RM/LL 1
120704302	K-MONO Tibia MetalBack RM/LL 2
120704303	K-MONO Tibia MetalBack RM/LL 3
120704304	K-MONO Tibia MetalBack RM/LL 4
120704305	K-MONO Tibia MetalBack RM/LL 5
120704306	K-MONO Tibia MetalBack RM/LL 6
120704321	K-MONO Tibia MetalBack RL/LM 1
120704322	K-MONO Tibia MetalBack RL/LM 2
120704323	K-MONO Tibia MetalBack RL/LM 3
120704324	K-MONO Tibia MetalBack RL/LM 4
120704325	K-MONO Tibia MetalBack RL/LM 5
120704326	K-MONO Tibia MetalBack RL/LM 6

Tibia MetalBack Cemented Titanium (suitable also as allergy)



Ref.	DESCRIPTION
120704301T	K-MONO Tibia MetBk Titanium RM/LL 1
120704302T	K-MONO Tibia MetBk Titanium RM/LL 2
120704303T	K-MONO Tibia MetBk Titanium RM/LL 3
120704304T	K-MONO Tibia MetBk Titanium RM/LL 4
120704305T	K-MONO Tibia MetBk Titanium RM/LL 5
120704306T	K-MONO Tibia MetBk Titanium RM/LL 6
120704321T	K-MONO Tibia MetBk Titanium RL/LM 1
120704322T	K-MONO Tibia MetBk Titanium RL/LM 2
120704323T	K-MONO Tibia MetBk Titanium RL/LM 3
120704324T	K-MONO Tibia MetBk Titanium RL/LM 4
120704325T	K-MONO Tibia MetBk Titanium RL/LM 5
120704326T	K-MONO Tibia MetBk Titanium RL/LM 6

Tibia MetalBack UnCemented Titanium (suitable also as allergy)



Ref.	DESCRIPTION
120704311T	K-MONO Tibia MB Ti UnCem RM/LL 1
120704312T	K-MONO Tibia MB Ti UnCem RM/LL 2
120704313T	K-MONO Tibia MB Ti UnCem RM/LL 3
120704314T	K-MONO Tibia MB Ti UnCem RM/LL 4
120704315T	K-MONO Tibia MB Ti UnCem RM/LL 5
120704316T	K-MONO Tibia MB Ti UnCem RM/LL 6
120704331T	K-MONO Tibia MB Ti UnCem RL/LM 1
120704332T	K-MONO Tibia MB Ti UnCem RL/LM 2
120704333T	K-MONO Tibia MB Ti UnCem RL/LM 3
120704334T	K-MONO Tibia MB Ti UnCem RL/LM 4
120704335T	K-MONO Tibia MB Ti UnCem RL/LM 5
120704336T	K-MONO Tibia MB Ti UnCem RL/LM 6

Screw for Tibia MetalBack UnCemented Titanium (suitable also as allergy)



Ref.	DESCRIPTION
120704501	K-MONO Screw 20mm
120704502	K-MONO Screw 25mm
120704503	K-MONO Screw 30mm
120704504	K-MONO Screw 35mm
120704505	K-MONO Screw 40mm
120704506	K-MONO Screw 45mm
120704507	K-MONO Screw 50mm



Insert X-Link Polyethylene + Vitamin E

Ref.	DESCRIPTION
120704201E	K-MONO Insert XLPE+VE RM/LL 1x8
120704202E	K-MONO Insert XLPE+VE RM/LL 2x8
120704203E	K-MONO Insert XLPE+VE RM/LL 3x8
120704204E	K-MONO Insert XLPE+VE RM/LL 4x8
120704205E	K-MONO Insert XLPE+VE RM/LL 5x8
120704206E	K-MONO Insert XLPE+VE RM/LL 6x8
120704211E	K-MONO Insert XLPE+VE RM/LL 1x9
120704212E	K-MONO Insert XLPE+VE RM/LL 2x9
120704213E	K-MONO Insert XLPE+VE RM/LL 3x9
120704214E	K-MONO Insert XLPE+VE RM/LL 4x9
120704215E	K-MONO Insert XLPE+VE RM/LL 5x9
120704216E	K-MONO Insert XLPE+VE RM/LL 6x9
120704221E	K-MONO Insert XLPE+VE RM/LL 1x10
120704222E	K-MONO Insert XLPE+VE RM/LL 2x10
120704223E	K-MONO Insert XLPE+VE RM/LL 3x10
120704224E	K-MONO Insert XLPE+VE RM/LL 4x10
120704225E	K-MONO Insert XLPE+VE RM/LL 5x10
120704226E	K-MONO Insert XLPE+VE RM/LL 6x10
120704231E	K-MONO Insert XLPE+VE RM/LL 1x12
120704232E	K-MONO Insert XLPE+VE RM/LL 2x12
120704233E	K-MONO Insert XLPE+VE RM/LL 3x12
120704234E	K-MONO Insert XLPE+VE RM/LL 4x12
120704235E	K-MONO Insert XLPE+VE RM/LL 5x12
120704236E	K-MONO Insert XLPE+VE RM/LL 6x12

Ref.	DESCRIPTION
120704251E	K-MONO Insert XLPE+VE RL/LM 1x8
120704252E	K-MONO Insert XLPE+VE RL/LM 2x8
120704253E	K-MONO Insert XLPE+VE RL/LM 3x8
120704254E	K-MONO Insert XLPE+VE RL/LM 4x8
120704255E	K-MONO Insert XLPE+VE RL/LM 5x8
120704256E	K-MONO Insert XLPE+VE RL/LM 6x8
120704261E	K-MONO Insert XLPE+VE RL/LM 1x9
120704262E	K-MONO Insert XLPE+VE RL/LM 2x9
120704263E	K-MONO Insert XLPE+VE RL/LM 3x9
120704264E	K-MONO Insert XLPE+VE RL/LM 4x9
120704265E	K-MONO Insert XLPE+VE RL/LM 5x9
120704266E	K-MONO Insert XLPE+VE RL/LM 6x9
120704271E	K-MONO Insert XLPE+VE RL/LM 1x10
120704272E	K-MONO Insert XLPE+VE RL/LM 2x10
120704273E	K-MONO Insert XLPE+VE RL/LM 3x10
120704274E	K-MONO Insert XLPE+VE RL/LM 4x10
120704275E	K-MONO Insert XLPE+VE RL/LM 5x10
120704276E	K-MONO Insert XLPE+VE RL/LM 6x10
120704281E	K-MONO Insert XLPE+VE RL/LM 1x12
120704282E	K-MONO Insert XLPE+VE RL/LM 2x12
120704283E	K-MONO Insert XLPE+VE RL/LM 3x12
120704284E	K-MONO Insert XLPE+VE RL/LM 4x12
120704285E	K-MONO Insert XLPE+VE RL/LM 5x12
120704286E	K-MONO Insert XLPE+VE RL/LM 6x12



Tibia AllPoly X-Link Polyethylene + Vitamin E

Ref.	DESCRIPTION
120704401E	K-MONO Tib AllP XLPE+VE RM/LL 1x8
120704402E	K-MONO Tib AllP XLPE+VE RM/LL 2x8
120704403E	K-MONO Tib AllP XLPE+VE RM/LL 3x8
120704404E	K-MONO Tib AllP XLPE+VE RM/LL 4x8
120704405E	K-MONO Tib AllP XLPE+VE RM/LL 5x8
120704406E	K-MONO Tib AllP XLPE+VE RM/LL 6x8
120704411E	K-MONO Tib AllP XLPE+VE RM/LL 1x9
120704412E	K-MONO Tib AllP XLPE+VE RM/LL 2x9
120704413E	K-MONO Tib AllP XLPE+VE RM/LL 3x9
120704414E	K-MONO Tib AllP XLPE+VE RM/LL 4x9
120704415E	K-MONO Tib AllP XLPE+VE RM/LL 5x9
120704416E	K-MONO Tib AllP XLPE+VE RM/LL 6x9
120704421E	K-MONO Tib AllP XLPE+VE RM/LL 1x10
120704422E	K-MONO Tib AllP XLPE+VE RM/LL 2x10
120704423E	K-MONO Tib AllP XLPE+VE RM/LL 3x10
120704424E	K-MONO Tib AllP XLPE+VE RM/LL 4x10
120704425E	K-MONO Tib AllP XLPE+VE RM/LL 5x10
120704426E	K-MONO Tib AllP XLPE+VE RM/LL 6x10
120704431E	K-MONO Tib AllP XLPE+VE RM/LL 1x12
120704432E	K-MONO Tib AllP XLPE+VE RM/LL 2x12
120704433E	K-MONO Tib AllP XLPE+VE RM/LL 3x12
120704434E	K-MONO Tib AllP XLPE+VE RM/LL 4x12
120704435E	K-MONO Tib AllP XLPE+VE RM/LL 5x12
120704436E	K-MONO Tib AllP XLPE+VE RM/LL 6x12

Ref.	DESCRIPTION
120704451E	K-MONO Tib AllP XLPE+VE RL/LM 1x8
120704452E	K-MONO Tib AllP XLPE+VE RL/LM 2x8
120704453E	K-MONO Tib AllP XLPE+VE RL/LM 3x8
120704454E	K-MONO Tib AllP XLPE+VE RL/LM 4x8
120704455E	K-MONO Tib AllP XLPE+VE RL/LM 5x8
120704456E	K-MONO Tib AllP XLPE+VE RL/LM 6x8
120704461E	K-MONO Tib AllP XLPE+VE RL/LM 1x9
120704462E	K-MONO Tib AllP XLPE+VE RL/LM 2x9
120704463E	K-MONO Tib AllP XLPE+VE RL/LM 3x9
120704464E	K-MONO Tib AllP XLPE+VE RL/LM 4x9
120704465E	K-MONO Tib AllP XLPE+VE RL/LM 5x9
120704466E	K-MONO Tib AllP XLPE+VE RL/LM 6x9
120704471E	K-MONO Tib AllP XLPE+VE RL/LM 1x10
120704472E	K-MONO Tib AllP XLPE+VE RL/LM 2x10
120704473E	K-MONO Tib AllP XLPE+VE RL/LM 3x10
120704474E	K-MONO Tib AllP XLPE+VE RL/LM 4x10
120704475E	K-MONO Tib AllP XLPE+VE RL/LM 5x10
120704476E	K-MONO Tib AllP XLPE+VE RL/LM 6x10
120704481E	K-MONO Tib AllP XLPE+VE RL/LM 1x12
120704482E	K-MONO Tib AllP XLPE+VE RL/LM 2x12
120704483E	K-MONO Tib AllP XLPE+VE RL/LM 3x12
120704484E	K-MONO Tib AllP XLPE+VE RL/LM 4x12
120704485E	K-MONO Tib AllP XLPE+VE RL/LM 5x12
120704486E	K-MONO Tib AllP XLPE+VE RL/LM 6x12

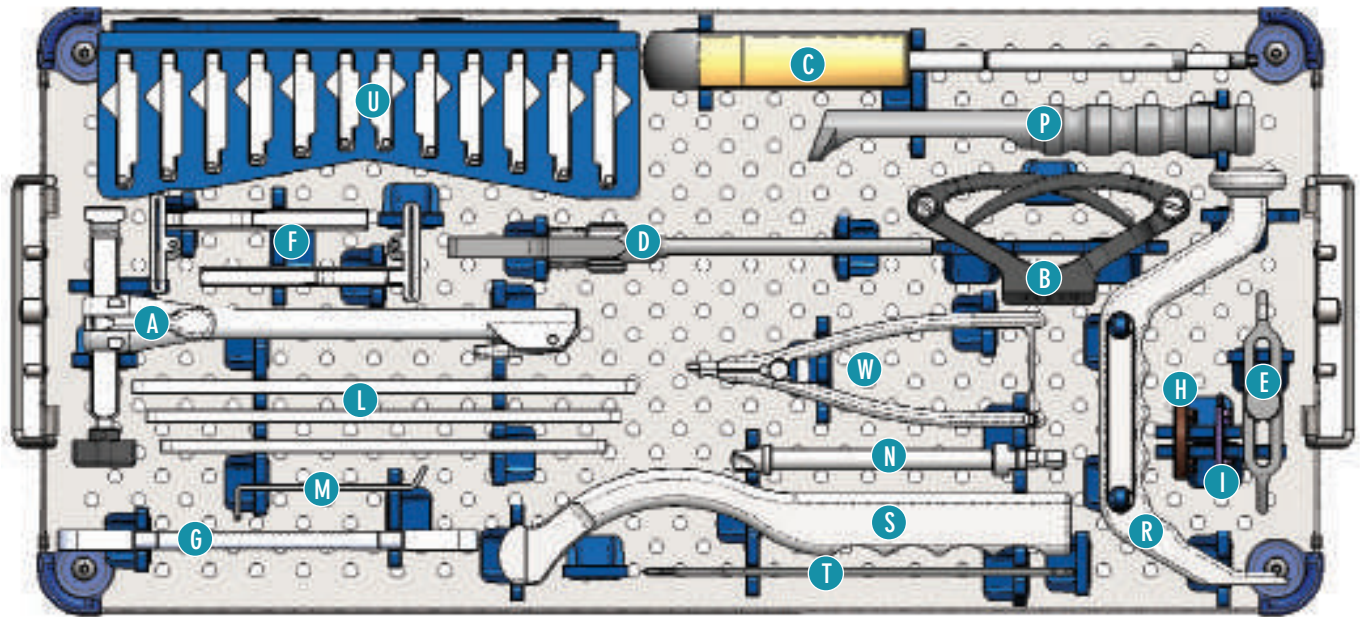

COD.	DESCRIPTION	Q.ty	REF.
300110122	K-MOD Tibial Distal Guide	1	A
300110133	K-MOD Ankle Clamp	1	B
340085045	Hex Screwdriver For Screws 4,5-6,5mm	1	C
300114000	K-MONO Proximal Tibial Guide	1	D
300114001	K-MONO Tibial Stylus 2-4mm	1	E
300114002	K-MONO Tibial Resection Block RM/LL	1	F
300114003	K-MONO Tibial Resection Block RL/LM	1	F
300114004	K-MONO Tibial Rasp	1	G
300114005	K-MONO Support Mod Tibia Impactor	1	H
300114006	K-MONO Support Mod Impactor ALUPE	1	I
300114010	K-MONO Tibial Sizer 1-2	1	L
300114011	K-MONO Tibial Sizer 3-4	1	L
300114012	K-MONO Tibial Sizer 5-6	1	L
300114013	K-MONO Tibial Ruler	1	M
300114015	K-MONO Drill Tibial Peg	1	N
300114016	K-MONO Tibial Impactor	1	P
300114018	K-MONO Modular Impactor Tib/ALUPE	1	R
300114019	K-MONO Broach AllPoly Fin	1	S
300114020	K-MONO Chisel AllPoly Fin	1	T

COD.	DESCRIPTION	Q.ty	REF.
300114021	K-MONO Trial Tib MetBack RM/LL 1	1	U
300114022	K-MONO Trial Tib MetBack RM/LL 2	1	U
300114023	K-MONO Trial Tib MetBack RM/LL 3	1	U
300114024	K-MONO Trial Tib MetBack RM/LL 4	1	U
300114025	K-MONO Trial Tib MetBack RM/LL 5	1	U
300114026	K-MONO Trial Tib MetBack RM/LL 6	1	U
300114031	K-MONO Trial Tib MetBack RL/LM 1	1	U
300114032	K-MONO Trial Tib MetBack RL/LM 2	1	U
300114033	K-MONO Trial Tib MetBack RL/LM 3	1	U
300114034	K-MONO Trial Tib MetBack RL/LM 4	1	U
300114035	K-MONO Trial Tib MetBack RL/LM 5	1	U
300114036	K-MONO Trial Tib MetBack RL/LM 6	1	U
300114040	K-MONO Nipper Trial Tib MetBack	1	W



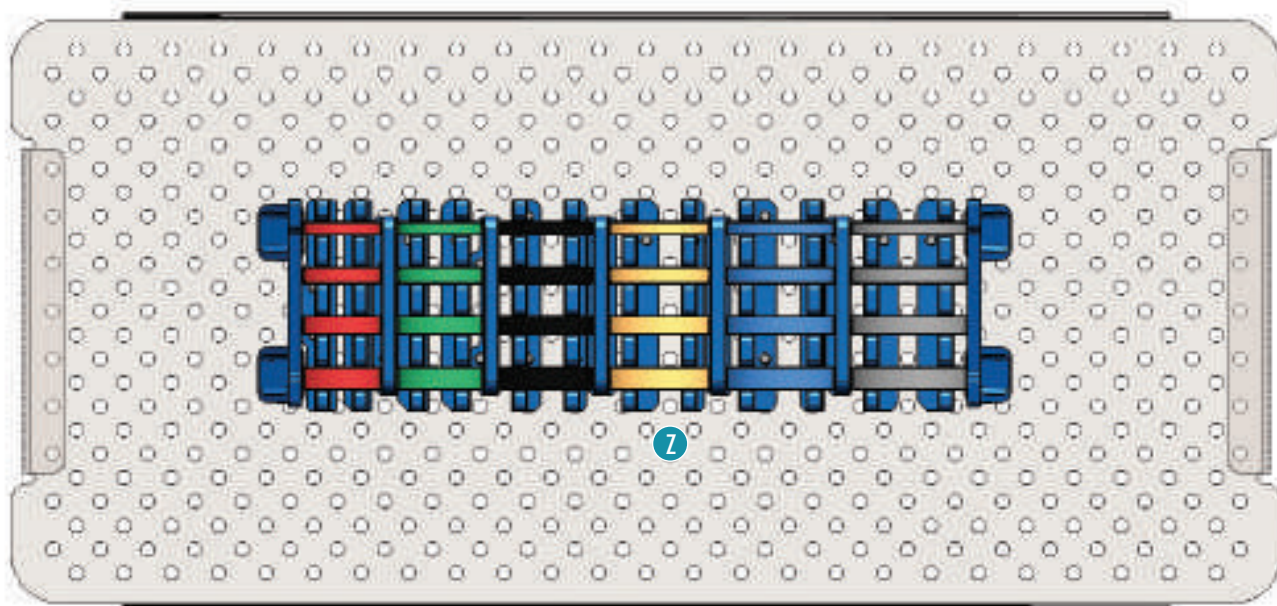

COD.	DESCRIPTION	Q.ty	REF.
300114041	K-MONO Trial Insert MetBack 8mm 1	1	Z
300114042	K-MONO Trial Insert MetBack 8mm 2	1	Z
300114043	K-MONO Trial Insert MetBack 8mm 3	1	Z
300114044	K-MONO Trial Insert MetBack 8mm 4	1	Z
300114045	K-MONO Trial Insert MetBack 8mm 5	1	Z
300114046	K-MONO Trial Insert MetBack 8mm 6	1	Z
300114051	K-MONO Trial Insert MetBack 9mm 1	1	Z
300114052	K-MONO Trial Insert MetBack 9mm 2	1	Z
300114053	K-MONO Trial Insert MetBack 9mm 3	1	Z
300114054	K-MONO Trial Insert MetBack 9mm 4	1	Z
300114055	K-MONO Trial Insert MetBack 9mm 5	1	Z
300114056	K-MONO Trial Insert MetBack 9mm 6	1	Z

COD.	DESCRIPTION	Q.ty	REF.
300114061	K-MONO Trial Insert MetBack 10mm 1	1	Z
300114062	K-MONO Trial Insert MetBack 10mm 2	1	Z
300114063	K-MONO Trial Insert MetBack 10mm 3	1	Z
300114064	K-MONO Trial Insert MetBack 10mm 4	1	Z
300114065	K-MONO Trial Insert MetBack 10mm 5	1	Z
300114066	K-MONO Trial Insert MetBack 10mm 6	1	Z
300114071	K-MONO Trial Insert MetBack 12mm 1	1	Z
300114072	K-MONO Trial Insert MetBack 12mm 2	1	Z
300114073	K-MONO Trial Insert MetBack 12mm 3	1	Z
300114074	K-MONO Trial Insert MetBack 12mm 4	1	Z
300114075	K-MONO Trial Insert MetBack 12mm 5	1	Z
300114076	K-MONO Trial Insert MetBack 12mm 6	1	Z
300114400	K-MONO Tibial Instruments Tray	1	-
300114410	K-MONO Generic Cover Large	1	-

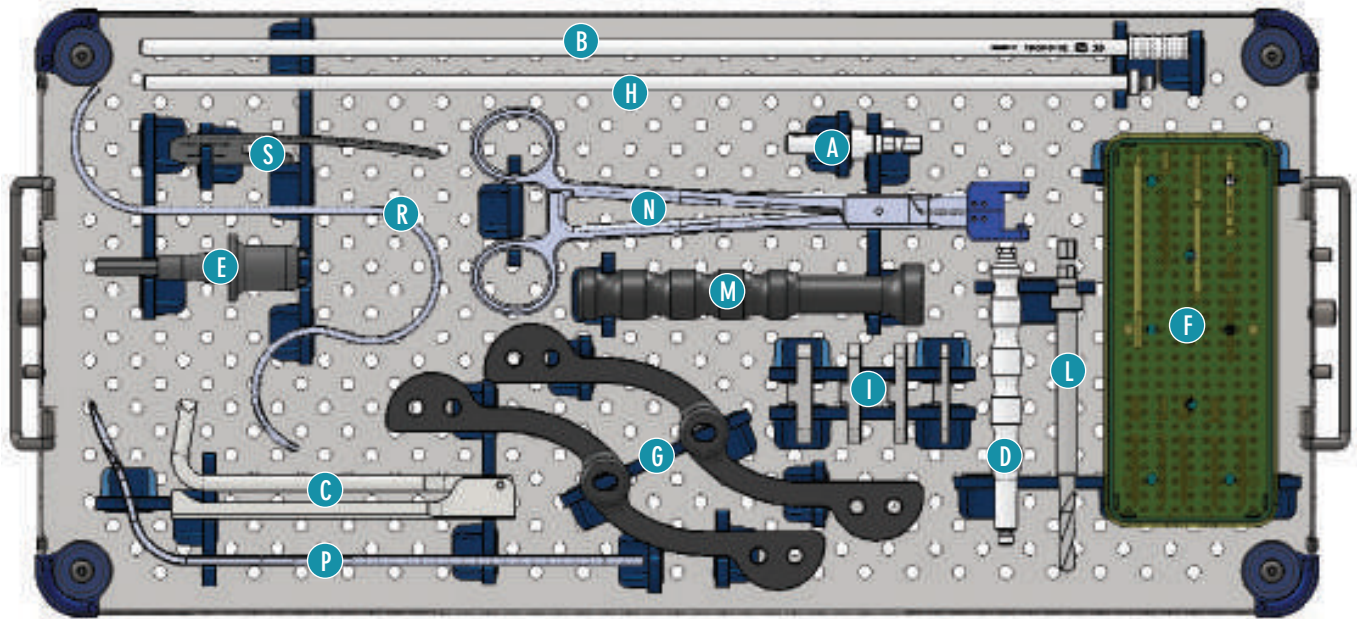

COD.	DESCRIPTION	Q.ty	REF.
110381525	Zimmer Adaptor	1	A
300110161	K-MOD Alignment Rod	1	B
300110276	K-MOD Pin Extractor	1	C
300110281	K-MOD Univ. Handle/Pin Extractor	1	D
300110377	K-MOD Jacobs Adaptor	1	E
300110144	K-MOD Pin 3,2 X 80mm	4	F
300110197	K-MOD Headed Pin For Baseplate	4	F
300110198	K-MOD Pin With Stop Diam 3,2mm L.40	4	F
300114135	K-MONO Threaded Pin 35mm 3,2/4,2mm	6	F
300114100	K-MONO Spacer Block TIB/PE 8/9mm	1	G
300114101	K-MONO Spacer Block TIB/PE 10/12mm	1	G
300114104	K-MONO Extension Alignment Rod	1	H

COD.	DESCRIPTION	Q.ty	REF.
300114105	K-MONO Plate Tibial Thickness 8mm	1	I
300114106	K-MONO Plate Tibial Thickness 9mm	1	I
300114107	K-MONO Plate Tibial Thickness 10mm	1	I
300114108	K-MONO Plate Tibial Thickness 12mm	1	I
300114120	K-MONO Drill Fem Peg Diam 6mm	1	L
300114121	K-MONO Femoral Impactor	1	M
300114122	K-MONO Femoral Positioner	1	N
300114130	K-MONO Patella Retractor	1	P
300114131	K-MONO Collateral S Retractor	1	R
300114132	K-MONO Angel Wing	1	S
300114401	K-MONO Common Instruments Tray	1	-
300114410	K-MONO Generic Cover Large	1	-

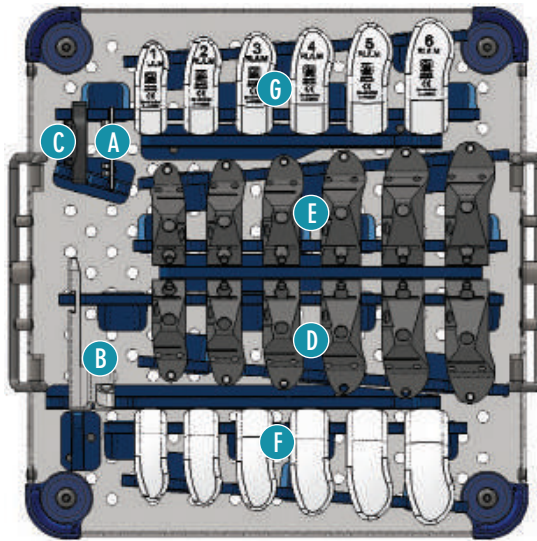

COD.	DESCRIPTION	Q.ty	REF.
300114300	K-MONO F3C Defect Plate Dist 2mm	1	A
300114301	K-MONO F3C Dist Res Block Modular	1	B
300114302	K-MONO F3C Spacer Block FEM	1	C
300114311	K-MONO F3C Res Block 2in1 RM/LL 1	1	D
300114312	K-MONO F3C Res Block 2in1 RM/LL 2	1	D
300114313	K-MONO F3C Res Block 2in1 RM/LL 3	1	D
300114314	K-MONO F3C Res Block 2in1 RM/LL 4	1	D
300114315	K-MONO F3C Res Block 2in1 RM/LL 5	1	D
300114316	K-MONO F3C Res Block 2in1 RM/LL 6	1	D
300114321	K-MONO F3C Res Block 2in1 RL/LM 1	1	E
300114322	K-MONO F3C Res Block 2in1 RL/LM 2	1	E
300114323	K-MONO F3C Res Block 2in1 RL/LM 3	1	E
300114324	K-MONO F3C Res Block 2in1 RL/LM 4	1	E
300114325	K-MONO F3C Res Block 2in1 RL/LM 5	1	E
300114326	K-MONO F3C Res Block 2in1 RL/LM 6	1	E

COD.	DESCRIPTION	Q.ty	REF.
300114331	K-MONO F3C Trial Fem 1 RM/LL	1	F
300114332	K-MONO F3C Trial Fem 2 RM/LL	1	F
300114333	K-MONO F3C Trial Fem 3 RM/LL	1	F
300114334	K-MONO F3C Trial Fem 4 RM/LL	1	F
300114335	K-MONO F3C Trial Fem 5 RM/LL	1	F
300114336	K-MONO F3C Trial Fem 6 RM/LL	1	F
300114341	K-MONO F3C Trial Fem 1 RL/LM	1	G
300114342	K-MONO F3C Trial Fem 2 RL/LM	1	G
300114343	K-MONO F3C Trial Fem 3 RL/LM	1	G
300114344	K-MONO F3C Trial Fem 4 RL/LM	1	G
300114345	K-MONO F3C Trial Fem 5 RL/LM	1	G
300114346	K-MONO F3C Trial Fem 6 RL/LM	1	G
300114403	K-MONO Fem 3CUT Instruments Tray	1	-
300114411	K-MONO Generic Cover Small	1	-

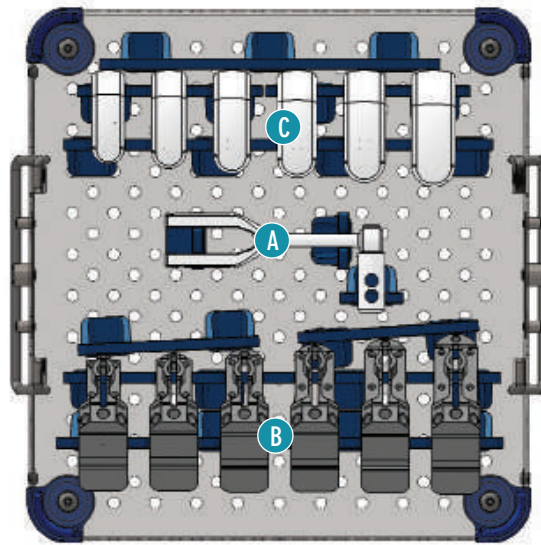

COD.	DESCRIPTION	Q.ty	REF.
300114200	K-MONO FRS Support EM Flex Rod	1	A
300114211	K-MONO FRS Resection Block 1	1	B
300114212	K-MONO FRS Resection Block 2	1	B
300114213	K-MONO FRS Resection Block 3	1	B
300114214	K-MONO FRS Resection Block 4	1	B
300114215	K-MONO FRS Resection Block 5	1	B
300114216	K-MONO FRS Resection Block 6	1	B

COD.	DESCRIPTION	Q.ty	REF.
300114221	K-MONO FRS Trial Fem 1	1	C
300114222	K-MONO FRS Trial Fem 2	1	C
300114223	K-MONO FRS Trial Fem 3	1	C
300114224	K-MONO FRS Trial Fem 4	1	C
300114225	K-MONO FRS Trial Fem 5	1	C
300114226	K-MONO FRS Trial Fem 6	1	C
300114402	K-MONO Fem RES Instruments Tray	1	-
300114411	K-MONO Generic Cover Small	1	-

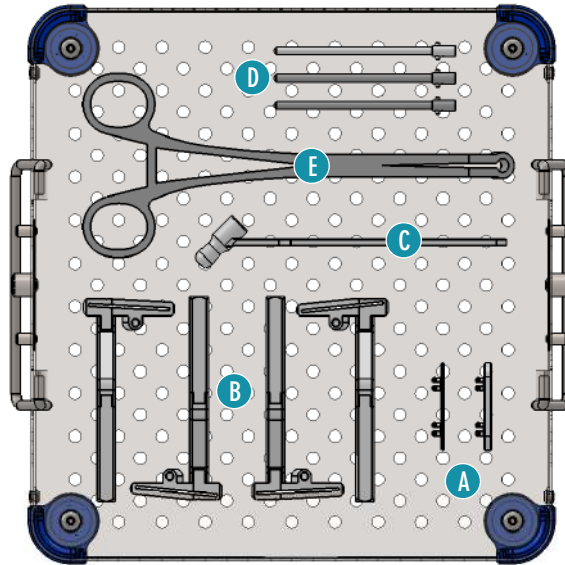

COD.	DESCRIPTION	Q.ty	REF.
300114305	K-MONO F3C Defect Plate Dist 1mm	1	A
300114306	K-MONO F3C Defect Plate Dist 3mm	1	A
300114080	K-MONO Tib Res Block RM Cartier 3	1	B
300114081	K-MONO Tib Res Block RM Cartier 6	1	B
300114082	K-MONO Tib Res Block LM Cartier 3	1	B
300114083	K-MONO Tib Res Block LM Cartier 6	1	B

COD.	DESCRIPTION	Q.ty	REF.
300114090	K-MONO Drillguide 3,2 Screw UnCem	1	C
300114091	Drill Bit Diam 3,2 mm L 130mm	3	D
110381681	Screw Holder	1	E
300114404	K-MONO Instrum Tray Option NATURAL	1	-
300114411	K-MONO Generic Cover Small	1	-

TEMPLATES

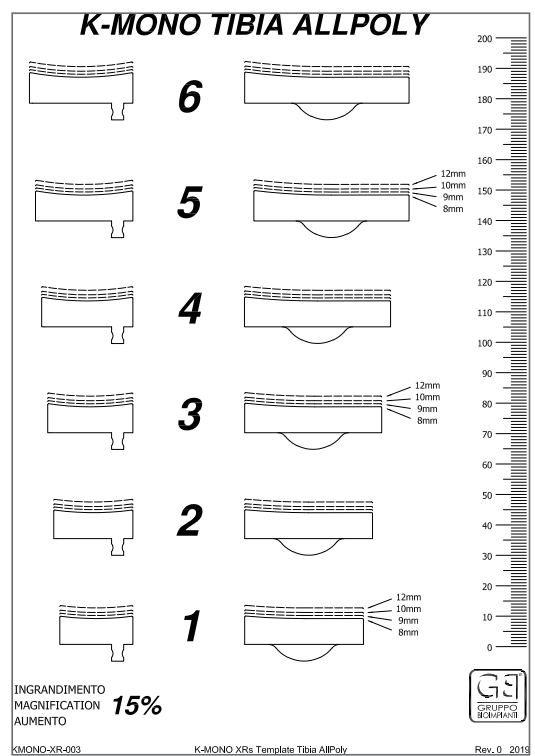
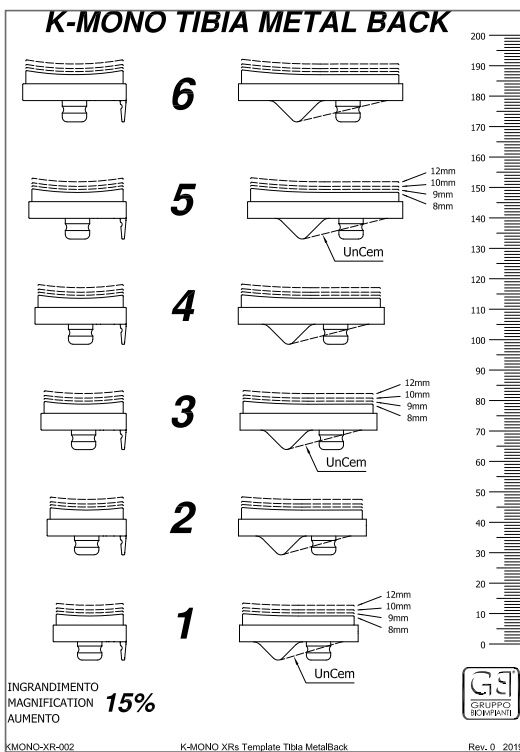
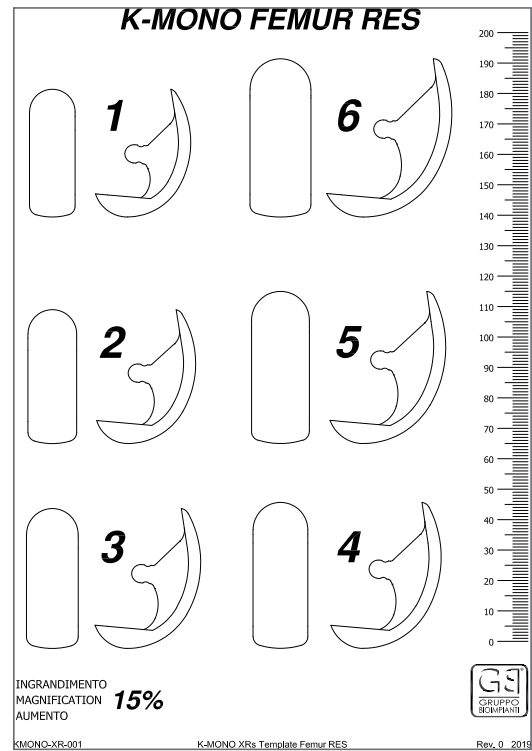
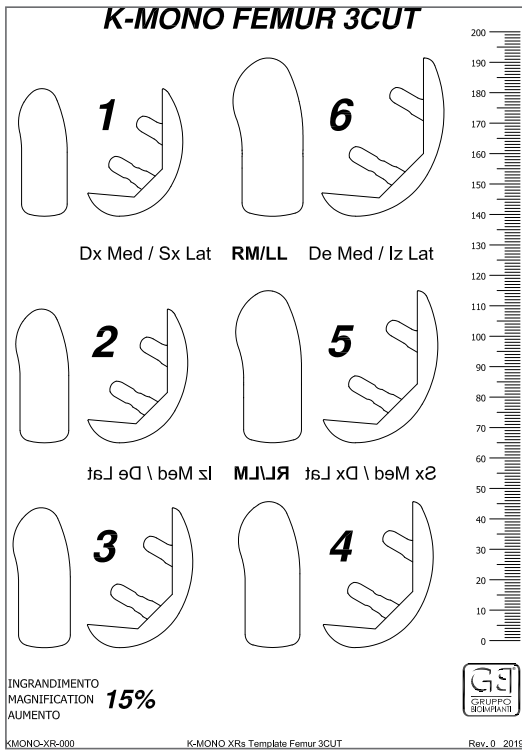

COD.	DESCRIPTION	REF.
KMONO-XR-000	K-MONO XRs Template Femur 3CUT	A
KMONO-XR-001	K-MONO XRs Template Femur RES	B
KMONO-XR-002	K-MONO XRs Template Tibia MetalBack	C
KMONO-XR-003	K-MONO XRs Template Tibia AllPoly	D

GB Website

Use the QR-Code to visit Gruppo Bioimpianti website



Operating technique video

Use the QR-Code to display the video that simulates the operating technique



IFU

Use the QR-Code to view complete product informations, including instructions for use, indications and contraindications, precautions and warnings



This surgical technique is exclusively intended for medical professionals, especially physicians and surgeons.

This document does not constitute medical advice, it does not dispense medical recommendations and it does not convey any diagnostic or therapeutic information.

Informations and techniques presented in this document were compiled by a team of medical experts and Gruppo Bioimpianti's specialists; however Gruppo Bioimpianti excludes any liability for improper use of informations.

For any information or enquires about this publication or anything else, contact GRUPPO BIOIMPIANTI.



Enjoy Mobility

GRUPPO BIOIMPIANTI S.R.L.

Via Liguria 28, 20068 Peschiera Borromeo (Milan) Italy

Tel. +39 02 51650371 - Fax +39 02 51650393

info@bioimpianti.it

bioimpianti.it

